

Mitutoyo

Quick Guide to Precision Measuring Instruments



IP65 COOLANT PROOF
0-25mm 0.001mm
Mitutoyo

Meaning of Symbols	02
Response to Safety and Environmental Protection Regulations	03
Quality Control	04
Micrometers	06
Micrometer Heads	12
Inside Micrometers	16
Calipers	18
Height Gages	24
Depth Gages	28
Gauge Blocks	29
Dial Indicators, Digital Indicators and Test Indicators	30
Linear Gages	35
Electronic Micrometers	39
Laser Scan Micrometers	40
Linear Scales	42
Profile Projectors	44
Microscopes	45
Vision Measuring Machines	47
Surftest (Surface Roughness Testers)	50
Contracer (Contour Measuring Instruments)	56
Roundtest (Roundform Measuring Instruments)	58
Hardness Testing Machines	62
Coordinate Measuring Machines	64

Meaning of Symbols

ABSOLUTE™

ABSOLUTE is a trademark of Mitutoyo Corporation.

IP65

IP66

IP67

IP is a trademark of Mitutoyo Corporation.



correct



incorrect

ABSOLUTE Linear Encoder

This is an electronic measuring scale that provides a direct readout of absolute linear position when switched on, without needing to be zeroed or reset. Mitutoyo measuring instruments incorporating these scales provide the significant benefit of being always ready for measurement without the need of preliminary setting after switching on. There are three types of absolute linear encoders depending on whether the method used is electrostatic, electromagnetic, or optical. They are widely used in various measuring instruments as measuring systems endowed with enhanced reliability of measured values.

Advantages:

1. No count error occurs even if you move the slider or spindle extremely rapidly.
2. You do not have to reset the system to zero when turning on the system after turning it off*1.
3. As this type of encoder can drive with less power than the incremental encoder, the battery life is prolonged to about 5 years (continuous operation of 18,000 hours)² under normal use.

*1: Unless the battery is removed.

*2: In the case of the ABSOLUTE Digimatic caliper (electrostatic capacitance model).

IP Codes

These are codes that indicate the degree of protection provided (by an enclosure) for the electrical function of a product against the ingress of foreign bodies, dust and water as defined in IEC standards (IEC 60529: 2001) and JIS C 0920: 2003.

[IEC: International Electrotechnical Commission]

IP (IP: International Protection)

First characteristic numeral	Degrees of protection against solid foreign objects		Second characteristic numeral	Degrees of protection against water	
	Brief description	Definition		Brief description	Definition
0	Unprotected	—	0	Unprotected	—
1	Protected against solid foreign objects of ≥ 50 mm and greater	A ≥ 50 mm object probe shall not fully penetrate enclosure*	1	Protected against vertical water drops	Vertically falling water drops shall have no harmful effects.
2	Protected against solid foreign objects of ≥ 12.5 mm and greater	A ≥ 12.5 mm object probe shall not fully penetrate enclosure*	2	Protected against vertical water drops within a tilt angle of 15°	Vertically falling water drops shall have no harmful effects when the enclosure is tilted at any angle up to 15° on either side of the vertical.
3	Protected against solid foreign objects of ≥ 2.5 mm and greater	A ≥ 2.5 mm object probe shall not fully penetrate enclosure*	3	Protected against spraying water	Water sprayed at an angle up to 60° either side of the vertical shall have no harmful effects.
4	Protected against solid foreign objects of ≥ 1.0 mm and greater	A ≥ 1.0 mm object probe shall not fully penetrate enclosure*	4	Protected against splashing water	Water splashed against the enclosure from any direction shall have no harmful effects.
5	Protected against dust	Ingress of dust is not totally prevented, but dust that does penetrate must not interfere with satisfactory operation of the apparatus or impair safety.	5	Protected against water jets	Water projected in jets against the enclosure from any direction shall have no harmful effects.
6	Dust-proof	No ingress of dust allowed.	6	Protected against powerful water jets	Water projected in powerful jets against the enclosure from any direction shall have no harmful effects.
			7	Protection against water penetration	Ingress of water in quantities causing harmful effects shall not be possible when the enclosure is temporarily immersed in water under standardized conditions of pressure and time.
			8	Protected against the effects of continuous immersion in water	Ingress of water in quantities causing harmful effects shall not be possible when the enclosure is continuously immersed in water under conditions which shall be agreed between manufacturer and user but which are more severe than for IPX7.

*: For details of the test conditions used in evaluating each degree of protection, please refer to the original standard.

TÜV Rheinland certification marks

All products with the marks shown on the left have passed the IP test carried out by the German accreditation organization, TÜV Rheinland.

CONVENTIONS USED IN THIS BOOKLET

The following symbols are used in this booklet to help the user obtain reliable measurement data through correct instrument operation.

Response to Safety and Environmental Protection Regulations

Conformance to CE Marking

In order to improve safety, each plant has programs to comply with the Machinery Directive, the EMC Directive, and the Low Voltage Directive. Compliance to CE marking is also met. CE stands for "Conformité Européenne". CE marking indicates that a product complies with the essential requirements of the relevant European health, safety and environmental protection legislation.

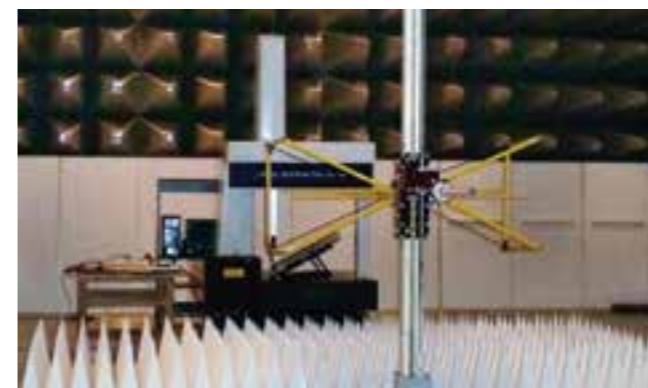

Conformity evaluation for CE marking (EMC Directives)

Major EU Directives relating to Mitutoyo products

Name of EU Directive	Applicable range
Machinery Directive	At least one part of a machine that may cause injury to the human body if it moves due to movement of an actuator such as a motor.
EMC Directive (Electromagnetic Compatibility Directive)	A product that may produce electromagnetic radiation or which is influenced by electromagnetic radiation from outside.
Low Voltage Directive	Equipment (device) that uses AC voltage of 50 to 1000 V or DC voltage of 75 to 1500 V.
Radio Equipment Directive	All electrical and electronic equipment that intentionally transmits and receives radio waves at frequencies below 3000 GHz.
RoHS Directive	Restriction of the use of certain hazardous substances in electrical and electronic equipment. Our products fall under Cat.9 "Monitoring and control instruments".

Response to WEEE Directive

The WEEE Directive*1 is a directive that mandates appropriate collection and recycling of electrical and electronic equipment waste.

The purpose of this directive is to increase the reuse and recycling of these products, and seeks eco-friendly product design.

To differentiate between equipment waste and household waste, a crossed-out wheeled-bin symbol is marked on a product.

We will promote eco-friendly design for our products.

*1 WEEE Directive: Directive 2012/19/EU of the European Parliament and of the Council on waste electrical and electronic equipment.

Response to REACH Regulation

REACH Regulation*2 is a regulation governing registration, evaluation, authorization and restriction of chemical substances in Europe, and all products such as substances, mixtures and molded products (including accessories and packaging materials) are regulated.

Chemical substances scientifically proven to be substances that are hazardous to human health and the global environment (Candidate List of substances of very high concern for Authorisation (CLS)) are prohibited to be sold or information concerning them disclosed is mandated in Europe.

We will actively disclose information about our products and provide replacement if we find our products contain any of the listed substances.

*2 REACH Regulation: Regulation (EC) No1907/2006 of the European Parliament and of the Council concerning the Registration, Evaluation, Authorization and Restriction of Chemicals

Response to Management Methods for Restricted Use of Hazardous Substances in Electrical and Electronic Product (China RoHS 2)

We set the environmental protection use period regulated by China RoHS 2 per product and label with the marks shown on the right, together with a list of the contained substances.



"Environmental Protection Use Period" mark*3

*3 The environmental protection use period does not indicate the product warranty period.

Quality Control

Quality control (QC)

A system for economically producing products or services of a quality that meets customer requirements.

Process quality control

Activities to reduce variation in product output by a process and keep this variation low. Process improvement and standardization as well as technology accumulation are promoted through these activities.

Statistical process control (SPC)

Process quality control through statistical methods.

Population

A group of all items that have characteristics to be considered for improving and controlling processes and quality of product. A group which is treated based on samples is usually the population represented by the samples.

Lot

Collection of product produced under the same conditions.

Sample

An item of product (or items) taken out of the population to investigate its characteristics.

Sample size

Number of product items in the sample.

Bias

Value calculated by subtracting the true value from the mean of measurement values when multiple measurements are performed.

Dispersion, Imprecision

Variation in the values of a target characteristic in relation to the mean value. Standard deviation is usually used to represent the dispersion of values around the mean.

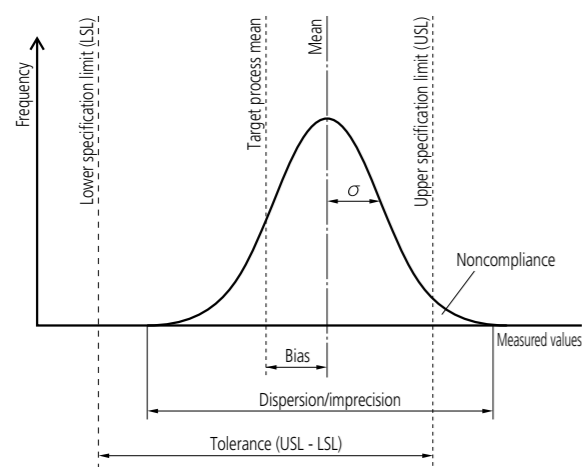

Histogram

A diagram that divides the range between the maximum and the minimum measurement values into several divisions and shows the number of values (appearance frequency) in each division in the form of a bar graph. This makes it easier to understand the rough average or the approximate extent of dispersion. A bell-shaped symmetric distribution is called the normal distribution and is much used in theoretical examples on account of its easily calculable characteristics. However, caution should be observed because many real processes do not conform to the normal distribution, and error will result if it is assumed that they do.

Process capability

Process-specific performance demonstrated when the process is sufficiently standardized, any causes of malfunctions are eliminated, and the process is in a state of statistical control. The process capability is represented by mean $\pm 3\sigma$ or 6σ when the quality characteristic output from the process shows normal distribution. σ (sigma) indicates standard deviation.

Process capability index (PCI or Cp)

The index value is calculated by dividing the tolerance of a target characteristic by the process capability (6σ). The value calculated by dividing the difference between the mean (\bar{X}) and the standard value by 3σ may be used to represent this index in cases of a unilateral tolerance. The process capability index assumes that a characteristic follows the normal distribution.

Note: If a characteristic follows the normal distribution, 99.74 % data is within the range $\pm 3\sigma$ from the mean.

Bilateral tolerance

$$C_p = \frac{USL - LSL}{6\sigma}$$

USL: Upper specification limit
LSL: Lower specification limit

Unilateral tolerance ... If only the upper limit is stipulated

$$C_p = \frac{USL - \bar{X}}{3\sigma}$$

Unilateral tolerance ... If only the lower limit is stipulated

$$C_p = \frac{\bar{X} - LSL}{3\sigma}$$

Specific examples of a process capability index (Cp) (bilateral tolerance)

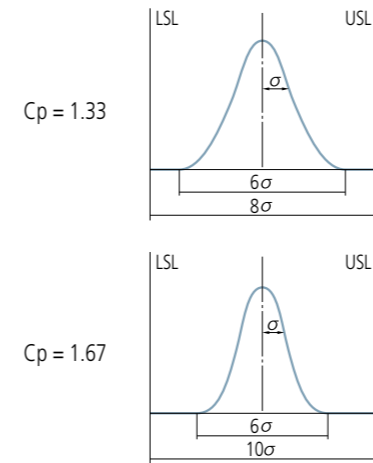
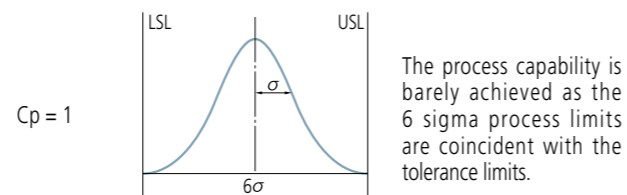

The process capability is the minimum value that can be generally accepted as it is no closer than 1 sigma to the tolerance limits.

The process capability is sufficient as it is no closer than 2 sigma to the tolerance limits.

Note that Cp only represents the relationship between the tolerance limits and the process dispersion and does not consider the position of the process mean.

Note: A process capability index that takes the difference between the process mean from the target process mean into consideration is generally called Cpk, which is the upper tolerance (USL minus the mean) divided by 3σ (half of process capability) or the lower tolerance (the mean value minus LSL) divided by 3σ , whichever is smaller.

Control chart

Used to control the process by separating the process variation into that due to chance causes and that due to a malfunction. The control chart consists of one center line (CL) and the control limit lines rationally determined above and below it (UCL and LCL). It can be said that the process is in a state of statistical control if all points are within the upper and lower control limit lines without notable trends when the characteristic values that represent the process output are plotted. The control chart is a useful tool for controlling process output, and therefore quality.

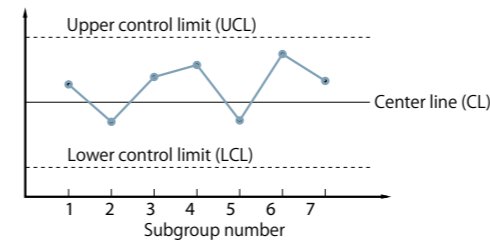

Chance causes

These causes of variation are of relatively low importance. Chance causes are technologically or economically impossible to eliminate even if they can be identified.

X-R control chart

A control chart used for process control that provides the most information on the process. The \bar{X} -R control chart consists of the \bar{X} control chart that uses the mean of each subgroup for control to monitor abnormal bias of the process mean and the R control chart that uses the range for control to monitor abnormal variation. Usually, both charts are used together.

How to read the control chart

Typical trends of successive point position in the control chart that are considered undesirable are shown below. These trends are taken to mean that a 'special cause' is affecting the process output and that action from the process operator is required to remedy the situation. These determination rules only provide a guideline. Take the process-specific variation into consideration when actually making determination rules. Assuming that the upper and the lower control limits are 3σ away from the center line, divide the control chart into six regions at intervals of 1σ to apply the following rules. These rules are applicable to the \bar{X} control chart and the X control chart. Note that these 'trend rules for action' were formulated assuming a normal distribution. Rules can be formulated to suit any other distribution.

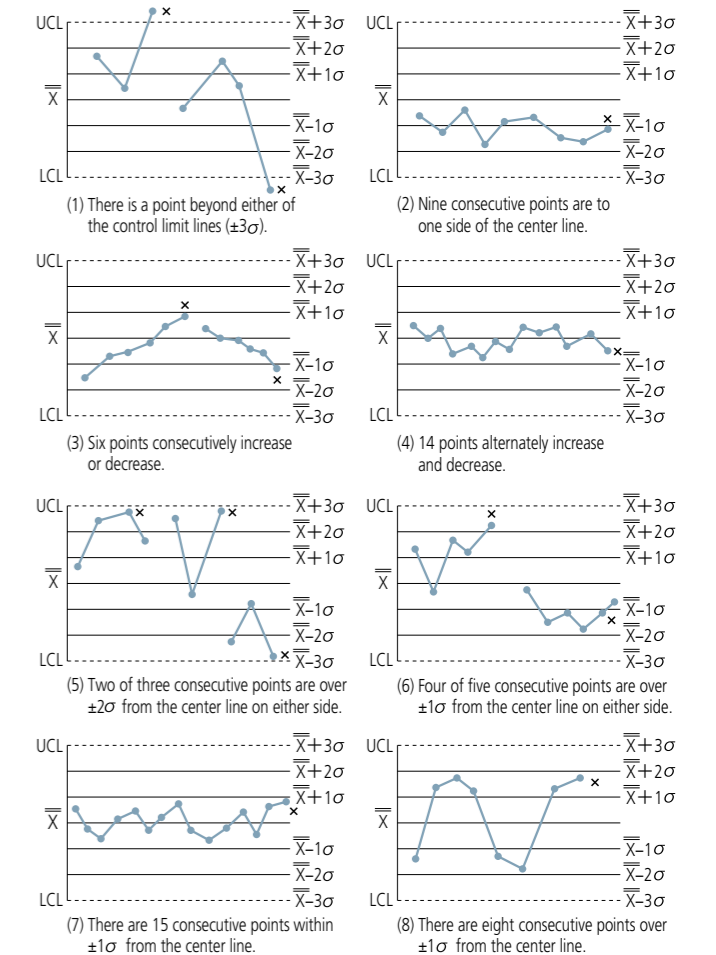

Note: This part of 'Quick Guide to Precision Measuring Instruments' (pages 6 and 7) has been written by Mitutoyo based on its own interpretation of the JIS Quality Control Handbook published by the Japanese Standards Association.

References

- JIS Quality Control Handbook (Japanese Standards Association) Z 8101:1981 Z 8101-1:1999 Z 8101-2:1999 Z 9020:1999 Z 9021:1998

Micrometers

Nomenclature

Standard Analog Outside Micrometer

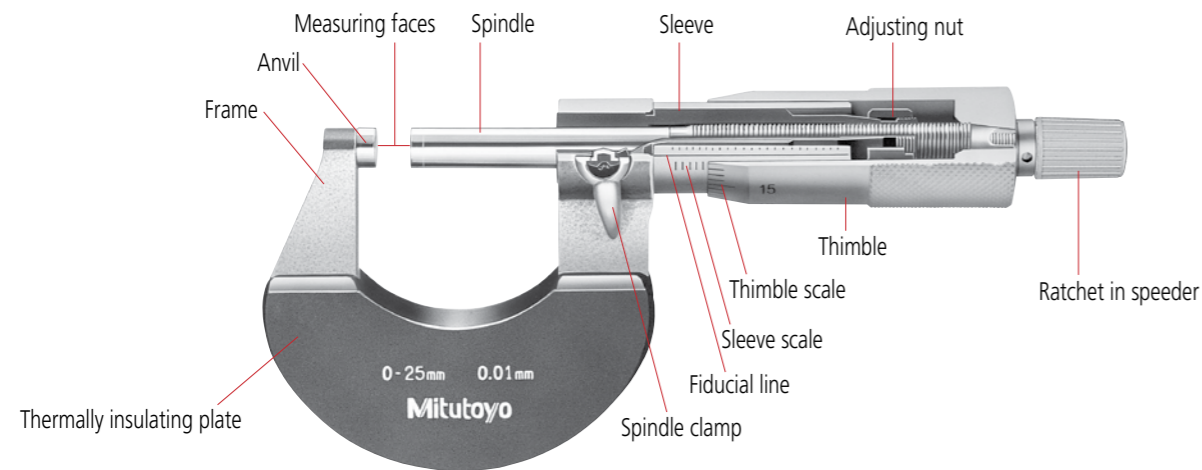

Digimatic Outside Micrometer

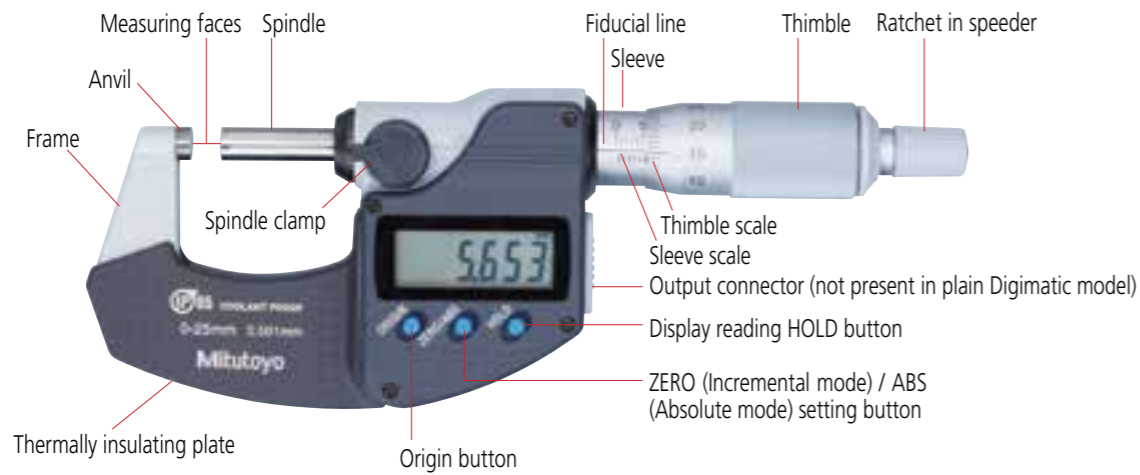

Special Purpose Micrometer Applications

Blade micrometer

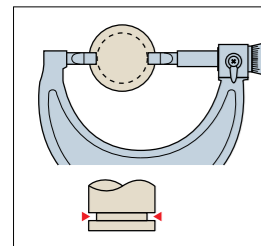

For inside diameter, and narrow groove measurement

Inside micrometer, caliper type

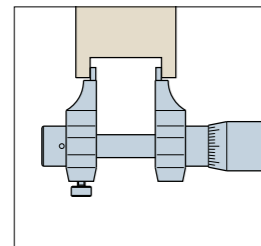

For small internal diameter, and groove width measurement

Spline micrometer

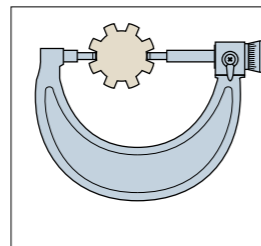

For splined shaft diameter measurement

Tube micrometer

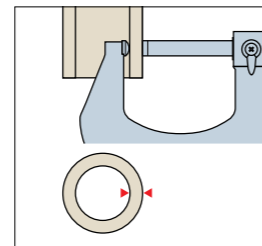

For pipe thickness measurement

Point micrometer

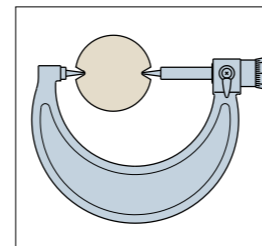

For root diameter measurement

Screw thread micrometer

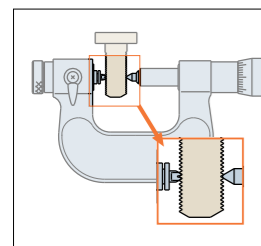

For effective thread diameter measurement

Disc type outside micrometer

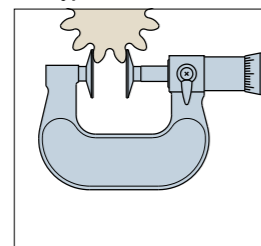

For root tangent measurement on spur gears and helical gears.

Ball tooth thickness micrometer

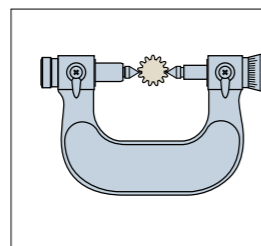

Measurement of gear over-pin diameter

V-anvil micrometer

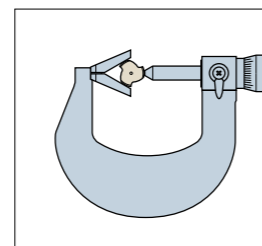

For measurement of 3- or 5-flute cutting tools

How to Read the Scale

Micrometer with standard scale (graduation: 0.01 mm)

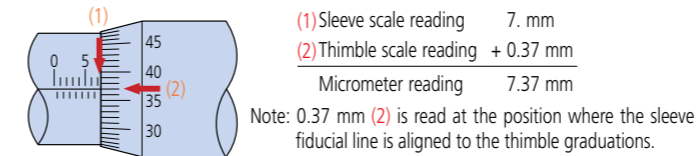

The thimble scale can be read directly to 0.01 mm, as shown above, but may also be estimated to 0.001 mm when the lines are nearly coincident because the line thickness is 1/5 of the spacing between them.

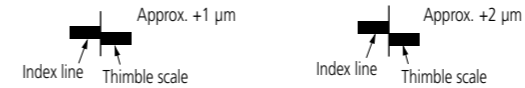

Micrometer with vernier scale (graduation: 0.001 mm)

The vernier scale provided above the sleeve index line enables direct readings to be made to within 0.001 mm.

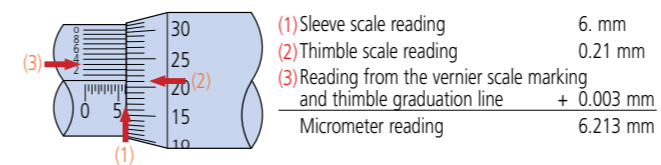

Note: 0.21 mm (2) is read at the position where the index line is between two graduations (21 and 22 in this case). 0.003 mm (3) is read at the position where one of the vernier graduations aligns with one of the thimble graduations.

Micrometer with mechanical-digit display (digital step: 0.001 mm)

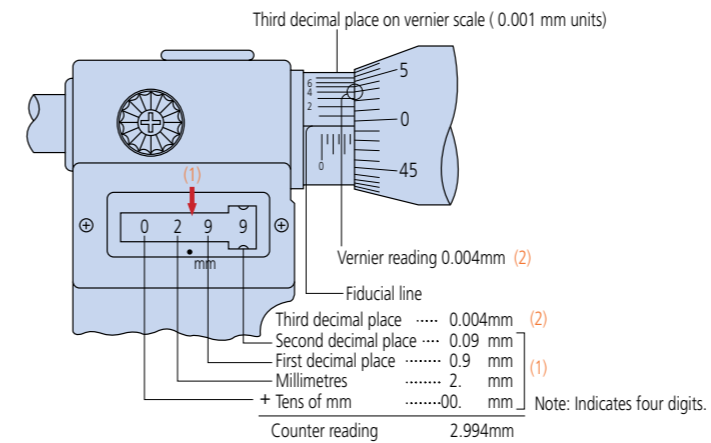

Note: 0.004 mm (2) is read at the position where a vernier graduation line corresponds with one of the thimble graduation lines.

Measuring Force Limiting Device

	Audible in operation	One-handed operation	Remarks
Ratchet stop	Yes	Unsuitable	Audible clicking operation causes micro-shocks
Friction thimble (F type)	No	Suitable	Smooth operation without shock or sound
Ratchet thimble	Yes	Suitable	Audible operation provides confirmation of constant measuring force

Measuring Face Detail

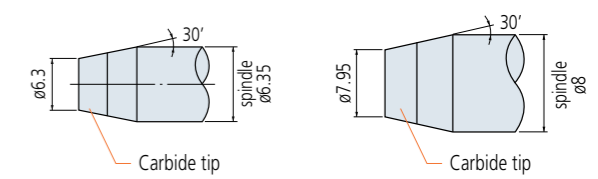

Note: The drawings above are for illustration only and are not to scale

Micrometer Expansion due to Holding Frame with the Bare Hand

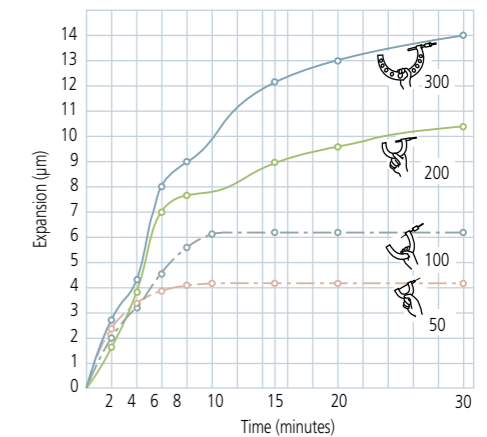

The above graph shows micrometer frame expansion due to heat transfer from hand to frame when the frame is held in the bare hand which, as can be seen, may result in a significant measurement error due to temperature-induced expansion. If the micrometer must be held by hand during measurement then try to minimize contact time. A heat insulator will reduce this effect considerably if fitted, or gloves may be worn. (Note that the above graph shows typical effects and is not guaranteed.)

Length Standard Expansion with Change of Temperature

(for 200 mm bar initially at 20 °C)

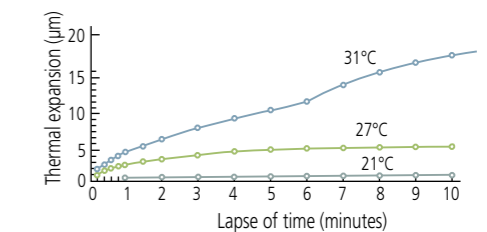

The above experimental graph shows how a particular micrometer standard expanded with time as people whose hand temperatures were different (as shown) held the end of it at a room temperature of 20 °C. This graph shows that it is important not to set a micrometer while directly holding the micrometer standard but to make adjustments only while wearing gloves or lightly supporting the length standard by its heat insulators. When performing a measurement, note also that it takes time until the expanded micrometer standard returns to the original length. (Note that the graph values are not guaranteed values but experimental values.)

Micrometers

Difference in Thermal Expansion between Micrometer and Length Standard

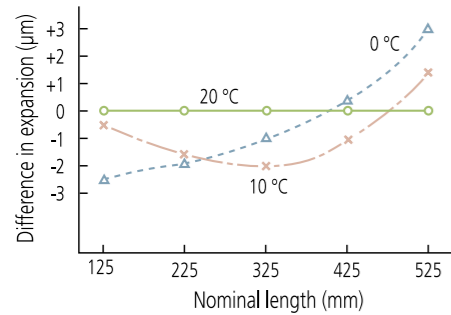

In the above experiment, after the micrometer and its standard were left at a room temperature of 20 °C for about 24 hours for temperature stabilization, the start point was adjusted using the micrometer standard. Then, the micrometer with its standard were left at the temperatures of 0 °C and 10 °C for about the same period of time, and the start point was tested for shift. The above graph shows the results for each of the sizes from 125 through 525 mm at each temperature. This graph shows that both the micrometer and its standard must be left at the same location for at least several hours before adjusting the start point. (Note that the graph values are not guaranteed values but experimental values.)

Hooke's Law

Hooke's law states that strain in an elastic material is proportional to the stress causing that strain, providing the strain remains within the elastic limit for that material.

Effect of Changing Support Method and Orientation

Changing the support method and/or orientation of a micrometer after zero setting affects subsequent measuring results. The tables below highlight the measurement errors to be expected in three other cases after micrometers are zero-set in the 'Supported at the bottom and center' case. These actual results show that it is best to set and measure using the same orientation and support method.

Supporting method	Supported at the bottom and center	Supported only at the center
Attitude		
Maximum measuring length (mm)		
325	0	-5.5
425	0	-2.5
525	0	-5.5
625	0	-11.0
725	0	-9.5
825	0	-18.0
925	0	-22.5
1025	0	-26.0

Supporting method	Supported at the center in a lateral orientation	Supported by hand downward
Attitude		
Maximum measuring length (mm)		
325	+1.5	-4.5
425	+2.0	-10.5
525	-4.5	-10.0
625	0	-5.5
725	-9.5	-19.0
825	-5.0	-35.0
925	-14.0	-27.0
1025	-5.0	-40.0

Abbe's Principle

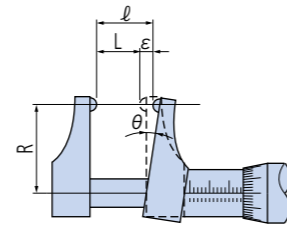

Abbe's principle states that "maximum accuracy is obtained when the scale and the measurement axes are common". This is because any variation in the relative angle (θ) of the moving measuring jaw on an instrument, such as a caliper jaw micrometer, causes displacement that is not measured on the instrument's scale and this is an Abbe error ($\epsilon = L - L'$ in the diagram). Spindle straightness error, play in the spindle guide or variation of measuring force can all cause (θ) to vary, and the error increases with R.

Hertz's Formula

Hertz's formula give the apparent reduction in diameter of spheres and cylinders due to elastic compression when measured between plane surfaces. These formula are useful for determining the deformation of a workpiece caused by the measuring force in point and line contact situations.

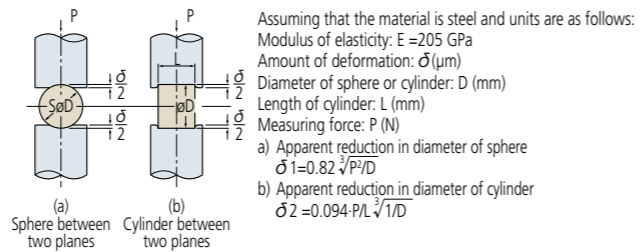

Major Measurement Errors of the Screw Micrometer

Error cause	Maximum possible error	Precautions for eliminating errors	Error that might not be eliminated even with precautions
Micrometer feed error	3 μm	1. Correct the micrometer before use.	$\pm 1 \mu\text{m}$
Anvil angle error	$\pm 5 \mu\text{m}$ assuming the error of a half angle is 15 minutes	1. Measure the angle error and correct the micrometer. 2. Adjust the micrometer using the same thread gage as the workpiece.	$\pm 3 \mu\text{m}$ expected measurement error of half angle
Misaligned contact points	+10 μm		+3 μm
Influence of measuring force	$\pm 10 \mu\text{m}$	1. Use a micrometer with a low measuring force if possible. 2. Always use the ratchet stop. 3. Adjust the micrometer using a thread gage with the same pitch.	+3 μm
Angle error of thread gage	$\pm 10 \mu\text{m}$	1. Perform correction calculation (angle). 2. Correct the length error. 3. Adjust the micrometer using the same thread gage as the workpiece.	+3 μm
Length error of thread gage	$\pm (3 + \frac{L}{25}) \mu\text{m}$	1. Perform correction calculation. 2. Adjust the micrometer using the same thread gage as the workpiece.	$\pm 1 \mu\text{m}$
Workpiece thread angle error	JIS 2 grade error of half angle ± 229 minutes -91 μm +71 μm	1. Minimize the angle error as much as possible. 2. Measure the angle error and perform correction calculation. 3. Use the three-wire method for a large angle error.	$\pm 8 \mu\text{m}$ assuming the error of half angle is ± 23 minutes
Cumulative error	$(\pm 117 + 40) \mu\text{m}$		+26 μm -12 μm

Screw Pitch Diameter Measurement

Three-wire method
 The screw pitch diameter can be measured with the three-wire method as shown in the figure. Calculate the pitch diameter (E) with equations (1) and (2).

Metric thread or unified screw (60°)
 $E = M - 3d + 0.866025P$ (1)

Whitworth thread (55°)
 $E = M - 3.16568d + 0.960491P$ (2)

d = Wire diameter
 E = Screw pitch diameter
 M = Micrometer reading including three wires
 P = Screw pitch
 (Convert inches to millimeters for unified screws.)

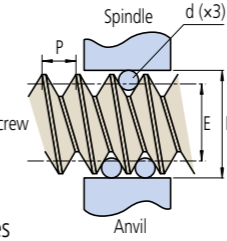

Thread type	Optimal wire size at D (P)
Metric thread or unified screw (60°)	0.577
Whitworth thread (55°)	0.564

Major Measurement Errors of the Three-wire Method

Error cause	Precautions for eliminating errors	Possible error	Error that might not be eliminated even with precautions
Pitch error (workpiece)	1. Correct the pitch error ($\delta p = \delta E$) 2. Measure several points and adopt their average. 3. Reduce single pitch errors.	$\pm 18 \mu\text{m}$ assuming that the pitch error is 0.02 mm.	$\pm 3 \mu\text{m}$
Error of half angle (workpiece)	1. Use the optimal wire diameter. 2. No correction is needed.	$\pm 0.3 \mu\text{m}$	$\pm 0.3 \mu\text{m}$
Due to anvil difference	1. Use the optimal wire diameter. 2. Use the wire which has a diameter close to the average at the one wire side.	$\pm 8 \mu\text{m}$	$\pm 1 \mu\text{m}$
Wire diameter error	1. Use the predetermined measuring force appropriate for the pitch. 2. Use the predetermined width of measurement edge. 3. Use a stable measuring force.	-3 μm	-1 μm
Cumulative error		In the worst case +20 μm -35 μm	When measured carefully +3 μm -5 μm

One-wire method

The pitch diameter of odd-fluted tap can be measured using the V-anvil micrometer with the one-wire method. Obtain the measured value (M_1) and calculate M with equation (3) or (4).

M_1 = Micrometer reading during one-wire measurement
 D = Odd-fluted tap diameter

Tap with three flutes : $M = 3M_1 - 2D$ (3)

Tap with five flutes : $M = 2.2360M_1 - 1.2360D$ (4)

Then, assign the calculated M to equation (1) or (2) to calculate the pitch diameter (E).

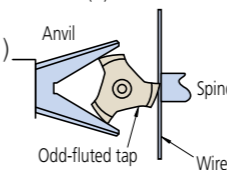

Root Tangent Length

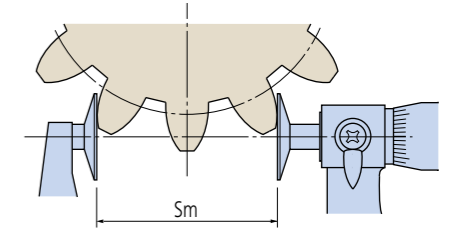

Formula for calculating a root tangent length (S_m):
 $S_m = m \cos \alpha_0 \{ \pi (Z_m - 0.5) + Z \text{inv} \alpha_0 \} + 2 X m \sin \alpha_0$

Formula for calculating the number of teeth within the root tangent length (Z_m):

$Z_m' = Z - K (f) + 0.5$ (Z_m is the integer closest to Z_m')

where, $K(f) = \frac{1}{\pi} \{ \sec \alpha_0 \sqrt{(1 + 2f)^2 - \cos^2 \alpha_0} - \text{inv} \alpha_0 - 2f \tan \alpha_0 \}$

and, $f = \frac{X}{Z}$

m: Module
 α_0 : Pressure angle
 Z: Number of teeth
 X: Addendum modification coefficient
 S_m : Root tangent length
 Z_m : Number of teeth within the root tangent length

$\text{inv } 20^\circ \approx 0.014904$
 $\text{inv } 14.5^\circ \approx 0.0055448$

Gear Measurement

Over-pin method

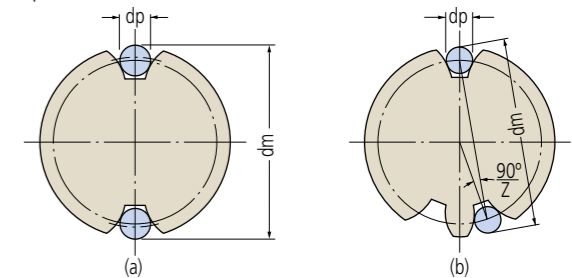

For a gear with an even number of teeth:

$d_m = d_p + \frac{d_g}{\cos \theta} = d_p + \frac{z \cdot m \cdot \cos \alpha_0}{\cos \theta}$

For a gear with an odd number of teeth:

$d_m = d_p + \frac{d_g}{\cos \theta} \cdot \cos \left(\frac{90^\circ}{z} \right) = d_p + \frac{z \cdot m \cdot \cos \alpha_0}{\cos \theta} \cdot \cos \left(\frac{90^\circ}{z} \right)$

however,

$\text{inv} \theta = \frac{d_p}{d_g} - \frac{X}{z} = \frac{d_p}{z \cdot m \cdot \cos \alpha_0} - \left(\frac{\pi}{2z} - \text{inv} \alpha_0 \right) + \frac{2 \tan \alpha_0}{z} \cdot X$

Obtain θ ($\text{inv} \theta$) from the involute function table.

z: Number of teeth
 α_0 : Pressure angle teeth
 m: Module
 X: Addendum modification coefficient

Micrometers

Testing Parallelism of Micrometer Measuring Faces

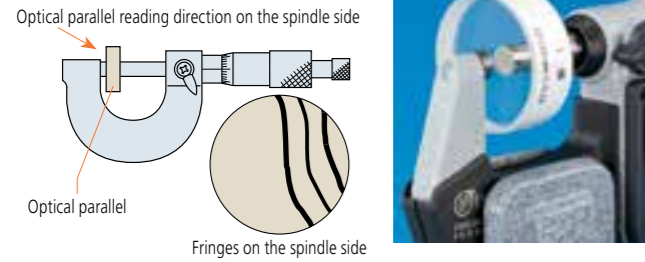

Parallelism can be estimated using an optical parallel held between the faces. First, bring the parallel to the anvil measuring face. Then close the spindle on the parallel using normal measuring force and count the number of red interference fringes seen on the measuring face of the spindle in white light. Each fringe represents a half wavelength difference in height (0.32 μm for red fringes). In the above figure a parallelism of approximately 1 μm is obtained from 0.32 $\mu\text{m} \times 3 = 0.96 \mu\text{m}$.

General Notes on Using the Micrometer

- Carefully check the type, measuring range, accuracy, and other specifications to select the appropriate model for your application.
- Leave the micrometer and workpiece at room temperature long enough for their temperatures to equalize before making a measurement.
- Look directly at the fiducial line when taking a reading against the thimble graduations. If the graduation lines are viewed from an angle, the correct alignment position of the lines cannot be read due to parallax error.

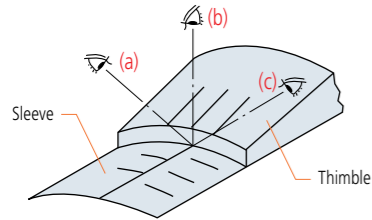

(a) From above the index line (b) Looking directly at the index line (c) From below the index line

- Wipe off the measuring faces of both the anvil and spindle with lint-free paper set the start (zero) point before measuring.



Testing Flatness of Micrometer Measuring Faces

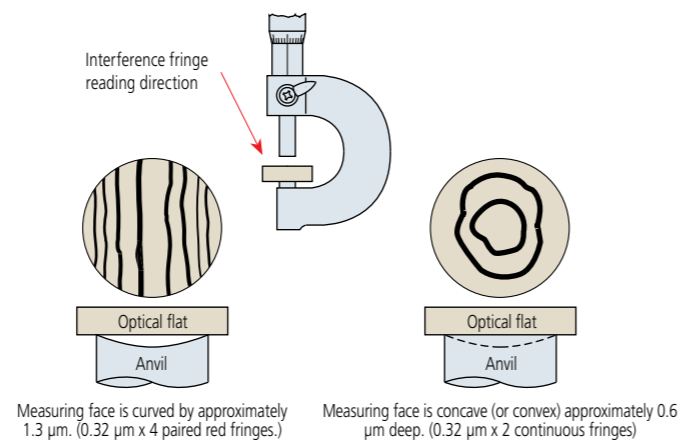

Measuring face is curved by approximately 1.3 μm . (0.32 $\mu\text{m} \times 4$ paired red fringes.)
Measuring face is concave (or convex) approximately 0.6 μm deep. (0.32 $\mu\text{m} \times 2$ continuous fringes)

- Wipe away any dust, chips and other debris from the circumference and measuring face of the spindle as part of daily maintenance. In addition, sufficiently wipe off any stains and fingerprints on each part with dry cloth.
- Use the constant-force device correctly so that measurements are performed with the correct measuring force.
- When attaching the micrometer onto a micrometer stand, the stand should clamp the center of the micrometer frame. Do not clamp it too tightly.

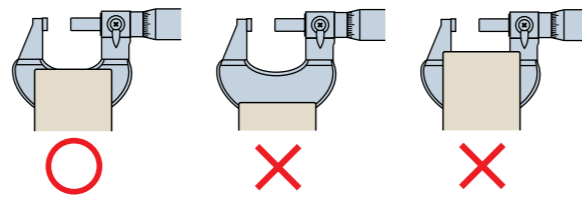

- Be careful not to drop or bump the micrometer on anything. Do not rotate the micrometer thimble using excessive force. If you believe a micrometer may have been damaged due to accidental mishandling, ensure that it is inspected for accuracy before further use.
- After a long storage period, or when there is no protective oil film visible, lightly apply anti-corrosion oil to the micrometer by wiping with a cloth soaked in it.
- Notes on storage:
 - Avoid storing the micrometer in direct sunlight.
 - Store the micrometer in a ventilated place with low humidity.
 - Store the micrometer in a place with little dust.
 - Store the micrometer in a case or other container, which should not be kept on the floor.
 - When storing the micrometer, always leave a gap of 0.1 to 1 mm between the measuring faces.
 - Do not store the micrometer in a clamped state.

Micrometer Performance Evaluation Method

JIS B 7502 was revised and issued in 2016 as the Japanese Industrial Standards of the micrometer, and the "Instrumental error" indicating the indication error of the micrometer has been changed to "Maximum Permissible Error (MPE) of indication".

The "Instrumental error" of the conventional JIS adopts acceptance criteria that the specification range (precision specification) equals acceptance range, and the OK/NG judgment does not include measurement uncertainty (Fig. 1). The "Maximum Permissible Error (MPE) of indication" of the new JIS employs the basic concept of the OK/NG judgment taking into account the uncertainty adopted in the ISO standard (ISO 14253-1). The verification of conformity and nonconformity to the specifications is clearly stipulated to use the internationally recognized acceptance criteria (simple acceptance) when the specification range equals the acceptance range, and it is accepted that the specification range equals the acceptance range if a given condition considering uncertainty is met.

The above said internationally recognized acceptance criterion is ISO/TR14253-6:2012 (Fig. 2).

The following describes the standard inspection method including the revised content of JIS 2016.

Fig. 1 Conventional JIS Instrumental error
JIS B 7502-1994

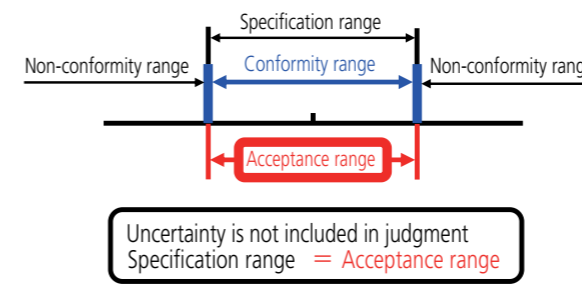
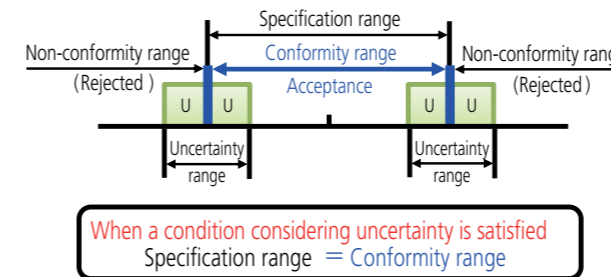

Fig. 2 New JIS Maximum Permissible Error (MPE)
JIS B 7502: 2016 (ISO/TR 14253-6: 2012)



Maximum Permissible Error of Full Surface Contact Error J_{MPE} [JIS B 7502: 2016]

The full surface contact error of the outside micrometer is an indication error measured by contacting the entire measuring surface with the object to be measured at an arbitrary point in the measuring range. The value can be obtained by adjusting the reference point using a constant pressure device with the minimum measuring length of the micrometer, inserting a grade 0 or 1 gauge block prescribed in JIS B 7506 or an equivalent or higher gauge between the measuring surfaces (Fig. 3), and then subtracting the dimensions of the gauge block from the indication value of the micrometer using a constant pressure device.

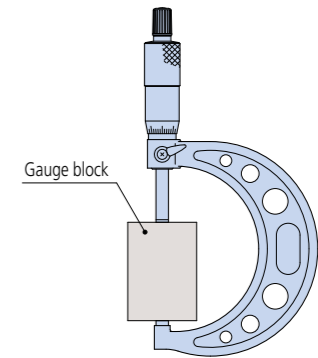

Fig. 3 Measurement of full surface contact error

Micrometer Heads

Key Factors in Selection

Key factors in selecting a micrometer head are the measuring range, spindle face, stem, graduations, thimble diameter, etc.

Stem

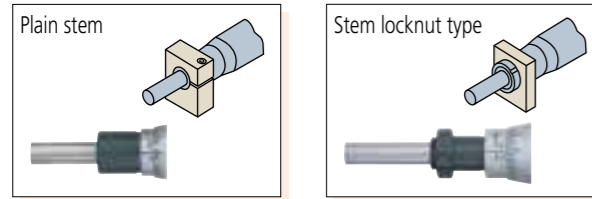

- The stem used to mount a micrometer head is classified as a "plain type" or "clamp nut type" as illustrated above. The stem diameter is manufactured to a nominal Metric or Imperial size with an h6 tolerance.
- The clamp nut stem allows fast and secure clamping of the micrometer head. The plain stem has the advantage of wider application and slight positional adjustment in the axial direction on final installation, although it does require a split-fixture clamping arrangement or adhesive fixing.
- General-purpose mounting fixtures are available as optional accessories.

Measuring Face



- A flat measuring face is often specified where a micrometer head is used in measurement applications.
- When a micrometer head is used as a feed device, a spherical face can minimize errors due to misalignment (Figure A). Alternatively, a flat face on the spindle can bear against a sphere, such as a carbide ball (Figure B).
- A non-rotating spindle type micrometer head or one fitted with an anti-rotation device on the spindle (Figure C) can be used if a twisting action on the workpiece must be avoided.
- If a micrometer head is used as a stop, then a flat face both on the spindle and the face it contacts provides durability.

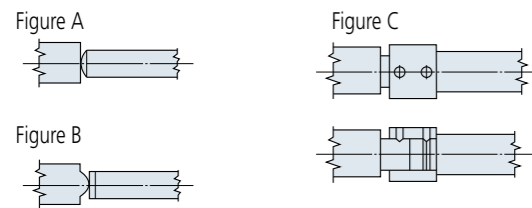

Non-Rotating Spindle

A non-rotating spindle type head does not exert a twisting action on a workpiece, which may be an important factor in some applications.

Spindle Thread Pitch

- The standard type head has 0.5 mm pitch.
- 1 mm-pitch type: quicker to set than standard type and avoids the possibility of a 0.5 mm reading error. Excellent load-bearing characteristics due to larger screw thread.
- 0.25 mm or 0.1 mm-pitch type
This type is the best for fine-feed or fine-positioning applications.

Constant-force Device

- A micrometer head fitted with a constant-force device (ratchet or friction thimble) is recommended for measurement applications.
- If using a micrometer head as a stop, or where saving space is a priority, a head without a ratchet is probably the best choice.



Micrometer head with constant-force device Micrometer head without constant-force device (no ratchet)

Spindle Lock

If a micrometer head is used as a stop it is desirable to use a head fitted with a spindle lock so that the setting will not change even under repeated shock loading.



Measuring Range (Stroke)

- When choosing a measuring range for a micrometer head, allow an adequate margin in consideration of the expected measurement stroke. Six stroke ranges, 5 mm to 50 mm, are available for standard micrometer heads.
- Even if the expected stroke is small, such as 2 mm to 3 mm, it will be cost effective to choose a 25 mm-stroke model as long as there is enough space for installation.
- If a long stroke of over 50 mm is required, the concurrent use of a gauge block can extend the effective measuring range. (Figure D)

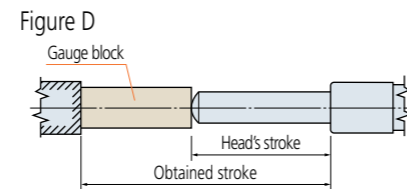

- In this guide, the range (or stroke end) of the thimble is indicated by a dashed line. For stroke ends, consider the thimble as moving to the position indicated by the line when designing the jig.

Ultra-fine Feed Applications

Dedicated micrometer heads are available for manipulator applications, etc., which require ultra-fine feed or adjustment of spindle.

Thimble Diameter

The diameter of a thimble greatly affects its usability and the "fineness" of positioning. A small-diameter thimble allows quick positioning whereas a large-diameter thimble allows fine positioning and easy reading of the graduations. Some models combine the advantages of both features by mounting a coarse-feed thimble (speeder) on the large-diameter thimble.



Graduation Styles

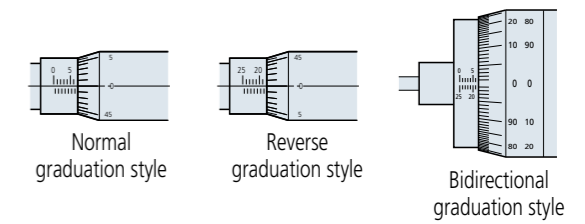

- Care is needed when taking a reading from a mechanical micrometer head, especially if the user is unfamiliar with the model.
- The "normal graduation" style, identical to that of an outside micrometer, is the standard. For this style the reading increases as the spindle retracts into the body.
- On the contrary, in the "reverse graduation" style the reading increases as the spindle advances out of the body.
- The "bidirectional graduation" style is intended to facilitate measurement in either direction by using black numerals for normal, and red numerals for reverse, operation.
- Micrometer heads with a mechanical or electronic digital display, which allow direct reading of a measurement value, are also available. These types are free from misreading errors. A further advantage is that the electronic digital display type can enable computer-based storage and statistical processing of measurement data.

Guidelines for Self-made Fixtures

A micrometer head should be mounted by the stem in an accurately machined hole using a clamping method that does not exert excessive force on the stem. There are three common mounting methods as shown below. Method (3) is not recommended. Adopt methods (1) or (2) wherever possible.

Mounting method	(1) Clamp nut				(2) Split-body clamp				(3) Setscrew clamp			
Points to keep in mind	Face A											
Stem diameter	ø9.5	ø10	ø12	ø18	ø9.5	ø10	ø12	ø18	ø9.5	ø10	ø12	ø18
Mounting hole Fitting tolerance	G7 +0.005 to +0.020		G7 +0.006 to +0.024		G7 +0.005 to +0.020		G7 +0.006 to +0.024		H5 0 to +0.006		H5 0 to +0.008	
Precautions	Care should be taken to make Face A square to the mounting hole. The stem can be clamped without any problem at squareness within 0.16/6.5.				Remove burrs generated on the wall of the mounting hole by the slitting operation.				M3x0.5 or M4x0.7 is an appropriate size for the setscrew. Limit countersinking into stem to 90°x0.5 and be careful not to damage the stem in the process.			

(Unit: mm)

Micrometer Heads

Custom-built Products (Product Example Introductions)

Micrometer heads have applications in many fields of science and industry and Mitutoyo offers a wide range of standard models to meet customers' needs. However, in those cases where the standard product is not suitable, Mitutoyo can custom build a head incorporating features better suited to your special application. Please feel free to contact Mitutoyo about the possibilities - even if only one custom-manufactured piece is required.

1. Spindle-end types

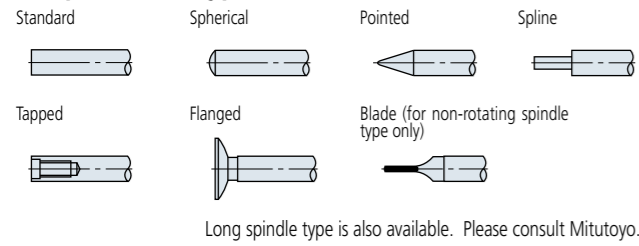

4. Logo engraving

A specific logo can be engraved as required.

5. Motor Coupling

Couplings for providing motor drive to a head can be designed.

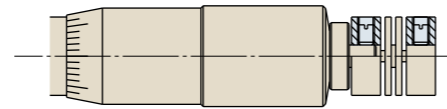

2. Stem types

A custom stem can be manufactured to suit the mounting fixture.

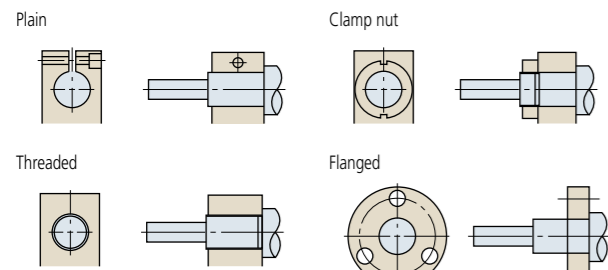

6. Thimble mounting

Thimble mounting methods including a ratchet, setscrew, and hex-socket head screw types are available.

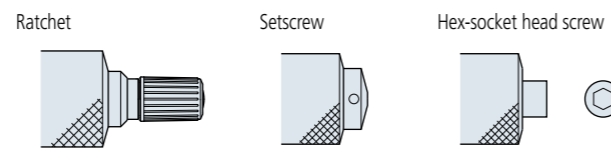

7. Spindle-thread pitch

Pitches of 1 mm for fast-feed applications or 0.25 mm and 0.1 mm for fine-feed can be supplied as alternatives to the standard 0.5 mm. Inch pitches are also supported. Please consult Mitutoyo for details.

8. Lubricant for spindle threads

Lubrication arrangements can be specified by the customer.

9. All-stainless construction

All components of a head can be manufactured in stainless steel.

10. Simple packaging

Large-quantity orders of micrometer heads can be delivered in simple packaging for OEM purposes.

11. Spindle and nut (Precision lead screw)

The spindle can be used as a precision lead screw. The nut is machined in accordance with the specified dimensions.

12. Accuracy inspection certificate

An accuracy inspection certificate can be supplied at extra cost. For detailed information, contact the nearest Mitutoyo Sales Office.

3. Scale graduation schemes

Various barrel and thimble scale graduation schemes, such as reverse and vertical, are available. Please consult Mitutoyo for ordering a custom scheme not shown here.

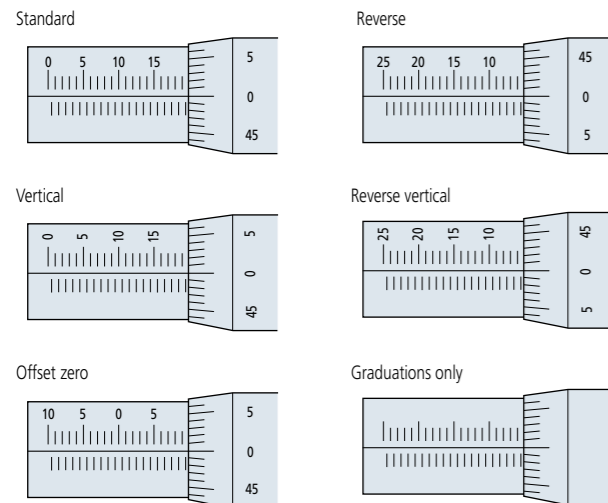

Maximum Loading Capacity of Micrometer Heads

The maximum loading capacity of a micrometer head depends mainly on the method of mounting and whether the loading is static or dynamic (used as a stop, for example). Therefore the maximum loading capacity of each model cannot be definitively specified. The loading limits recommended by Mitutoyo (at less than 100,000 revolutions if used for measuring within the guaranteed accuracy range) and the results of static load tests using a small micrometer head are given below.

1. Recommended maximum loading limit

		Maximum loading limit
Standard type	(spindle pitch: 0.5 mm)	Up to approx. 4 kgf *
	Spindle pitch: 0.1 mm/0.25 mm	Up to approx. 2 kgf
High-functionality type	Spindle pitch: 0.5 mm	Up to approx. 4 kgf
	Spindle pitch: 1.0 mm	Up to approx. 6 kgf
	Non-rotating spindle	Up to approx. 2 kgf
	MHF micro-fine feed type (with a differential mechanism)	Up to approx. 2 kgf

* Up to approx. 2 kgf only for MHT

2. Static load test for micrometer heads (using 148-104/148-103 for this test)

Test method

Micrometer heads were set up as shown and the force at which the head was damaged or pushed out of the fixture when a static load was applied, in direction P, was measured. (In the tests no account was taken of the guaranteed accuracy range.)

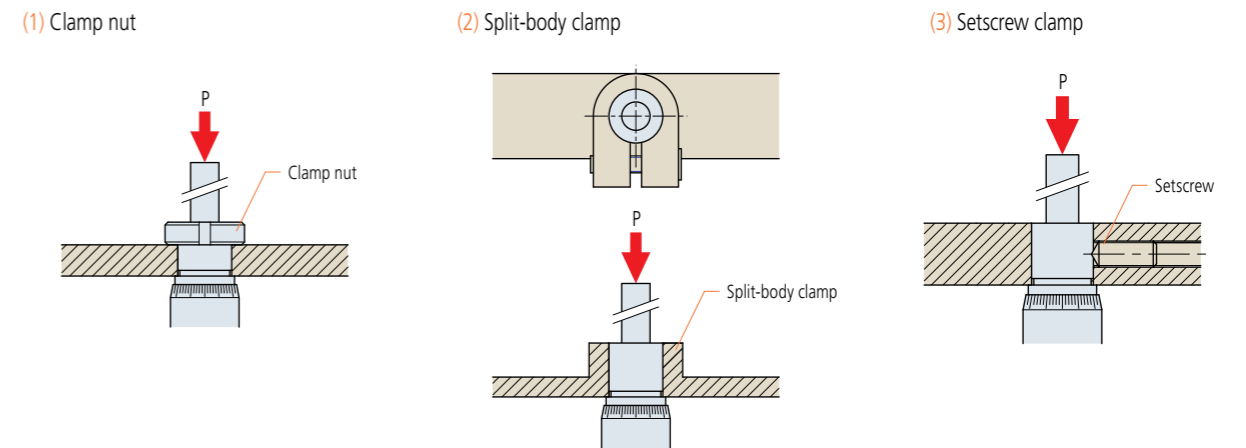

Mounting method	Damaging / dislodging load*
(1) Clamp nut	Damage to the main unit will occur at 8.63 to 9.8 kN (880 to 1000 kgf).
(2) Split-body clamp	The main unit will be pushed out of the fixture at 0.69 to 0.98 kN (70 to 100 kgf).
(3) Setscrew clamp	Damage to the setscrew will occur at 0.69 to 1.08 kN (70 to 110 kgf).

Note: These load values should only be used as an approximate guide.



Inside Micrometers

Nomenclature (Holtest)

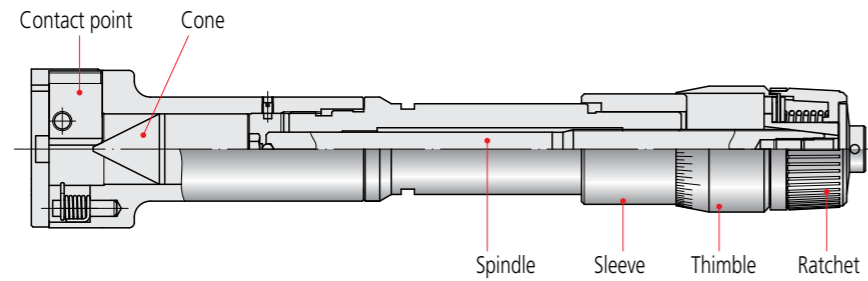

Custom-ordered Products (Holtest / Borematic)

Mitutoyo can custom-build an inside micrometer best suited to your special application. Please feel free to contact Mitutoyo about the possibilities - even if only one custom-manufactured piece is required. Please note that, depending on circumstances, such a micrometer will usually need to be used with a master setting ring for accuracy assurance. (A custom-ordered micrometer can be made compatible with a master ring supplied by the customer. Please consult Mitutoyo.)

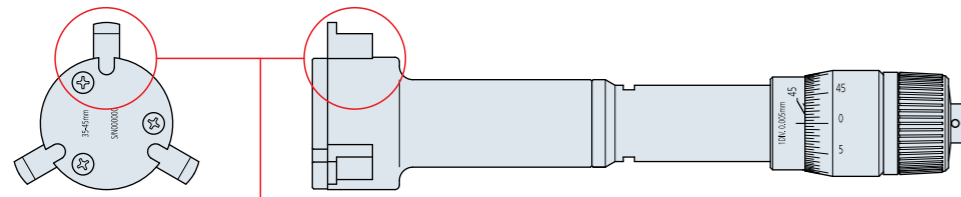

Type of feature	Workpiece profile (example)	Contact point tip profile (example)	Remarks
Square groove			
Round groove			<ul style="list-style-type: none"> Allows measurement of the diameter of variously shaped inside grooves and splines. Minimum measurable groove diameter is approximately 16 mm (differs depending on the workpiece profile.) Dimension l should be as follows: For $W = \text{less than } 2 \text{ mm}$: $l = \text{less than } 2 \text{ mm}$ For $W = 2 \text{ mm or more}$: $l = 2 \text{ mm}$ as the standard value which can be modified according to circumstances.
Spline			<ul style="list-style-type: none"> The number of splines or serrations is limited to a multiple of 3. Details of the workpiece profile should be provided at the time of placing a custom-order. If your application needs a measuring range different from that of the standard inside micrometer an additional initial cost for the master ring gage will be required.
Serration			
Threaded hole			<ul style="list-style-type: none"> Allows measurement of the effective diameter of an internal thread. Measurable internal threads are restricted according to the type, nominal dimension, and pitch of the thread. Please contact Mitutoyo with the specification of the thread to be measured for advice.

How to Read the Scale

Graduation	0.005 mm
(1) Outer sleeve	35 mm
(2) Thimble	0.015 mm
Reading	35.015 mm

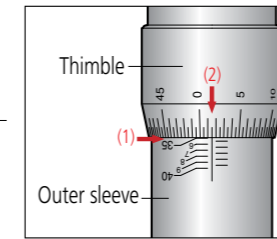

Changes in measured values at different measuring points

When Holtest is used, the measured value differs between measurement across the anvil and the measurement only at the tip of the anvil due to the product mechanism. Adjust the start point under the same condition before measurement.

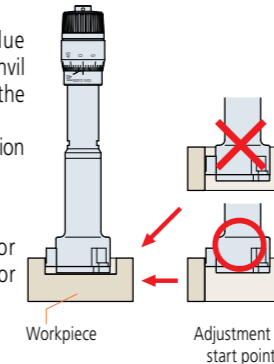

When you use the tip of the anvil for measurement, adjust the start point for using the tip of the anvil.

Measurement error due to temperature effects on an inside micrometer

The accuracy of an inside micrometer is degraded if its temperature is significantly different from. To help prevent this situation occurring wear gloves and only hold the micrometer by the heat insulators to reduce the transfer of heat from the operator's hands.

Effect of misalignment on accuracy (Inside Micrometer)

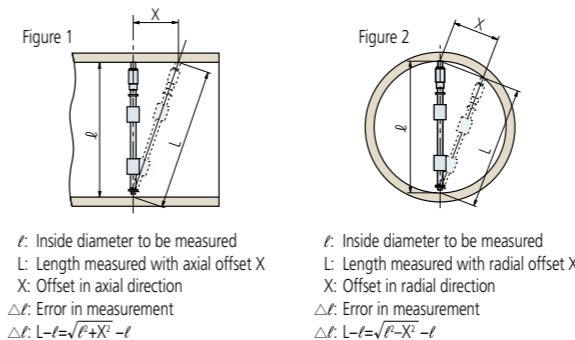

If the Inside Micrometer is misaligned in the axial or radial direction by an offset distance X when a measurement is taken, as in Figures 1 and 2, then that measurement will be in error as shown in the graph below (constructed from the formula given above). The error is positive for axial misalignment and negative for radial misalignment.

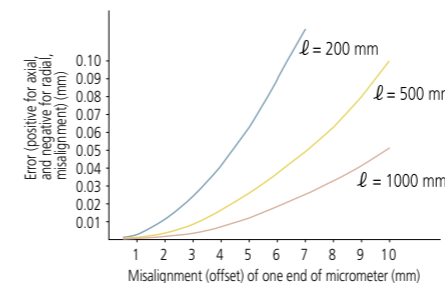

Airy and Bessel Points

When a length standard bar or inside micrometer lies horizontally, supported as simply as possible at two points, it bends under its own weight into a shape that depends on the spacing of those points. There are two distances between the points that control this deformation in useful ways, as shown below.

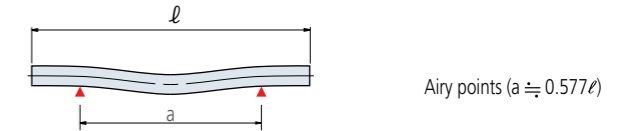

The ends of a bar (or micrometer) can be made exactly horizontal by spacing the two supports symmetrically as shown above. These points are known as the 'Airy Points' and are commonly used to ensure that the ends of a length bar are parallel to one another, so that the length is well defined.

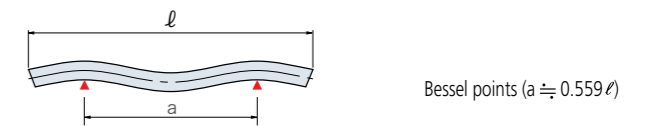

The change in length of a bar (or micrometer) due to bending can be minimized by spacing the two supports symmetrically as shown above. These points are known as the 'Bessel Points' and may be useful when using a long inside micrometer.

Reference point setting (2-point gages)

- Reference point setting with a ring gage or cylinder master gage: Insert the bore gage into the ring gage, vertically or horizontally swing the bore gage, and set the zero point to the point where the indicator reads the maximum value. (Rotate the dial face for a dial gage and perform presetting or zero setting for a Digimatic indicator.)
- Reference point setting with outside micrometer and gauge block: Hold a gauge block (of the reference dimension) between a micrometer's measuring faces as if measuring the block. Clamp the micrometer's spindle and then pull out the gauge block. Insert the bore gage between the micrometer's measuring faces. Maneuver the bore gage to the position where the indicator reads a minimum and then set the pointer to read zero (or a preset value required) by rotating the bezel.
- Reference point setting with outside micrometer only: Fix the micrometer in a vertical attitude with its head side (spindle side) downward (see illustration below), and then adjust the distance between the measuring faces to the reference dimension. At this time, do not clamp the micrometer spindle. Insert the bore gage between the micrometer's measuring faces. Maneuver the bore gage to the position where the indicator reads a minimum and then set the pointer to read zero (or a preset value required) by rotating the bezel. Zero-setting with a micrometer requires a certain degree of dexterity because no self-centering action is available, as is the case when using a setting gage. Zero-setting is also possible by performing the same procedure using the gauge block, height master, or bore gage zero checker in addition to the outside micrometer.

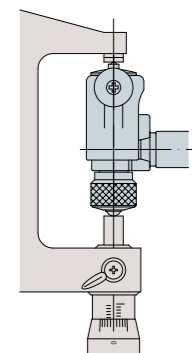

Calipers

Nomenclature

Vernier Caliper

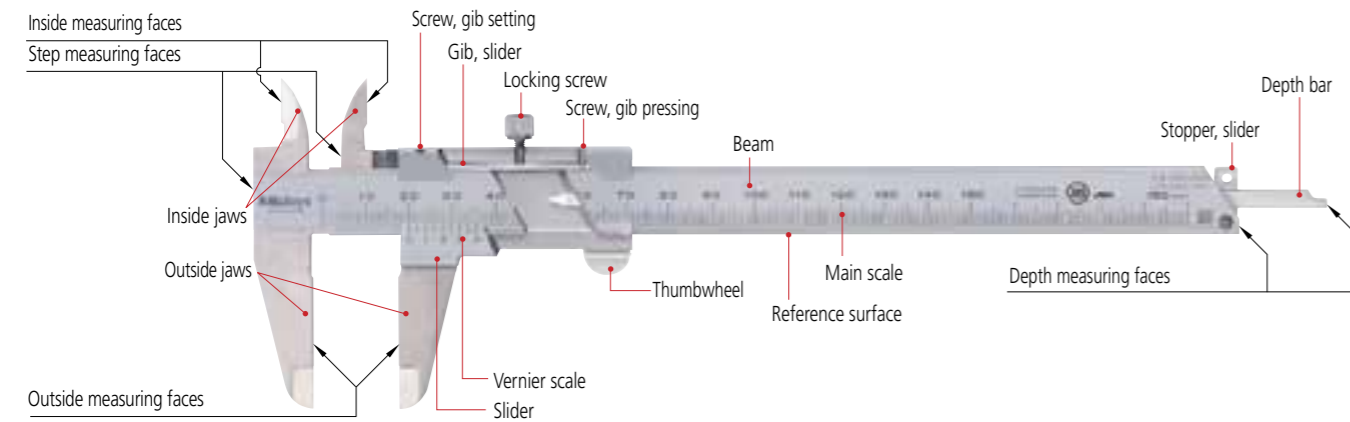

Absolute Digimatic Caliper

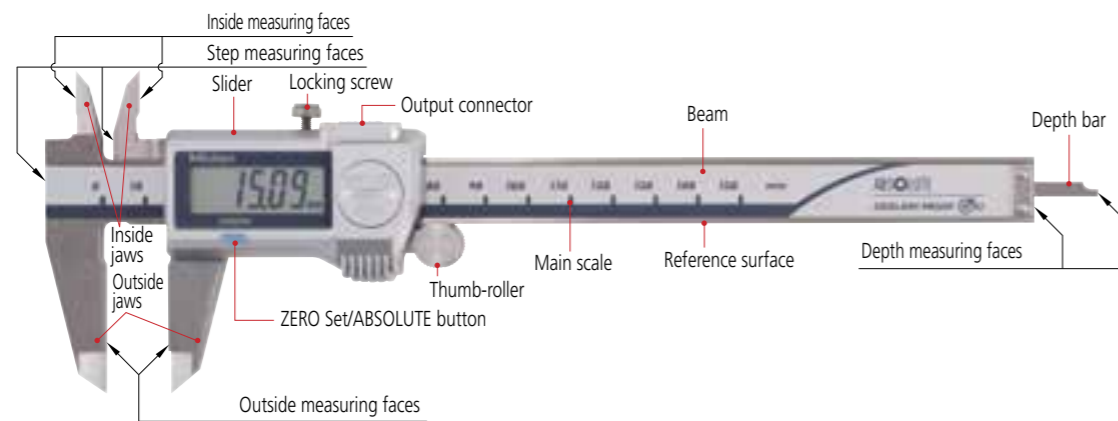

How to Read the Scale

Vernier Calipers

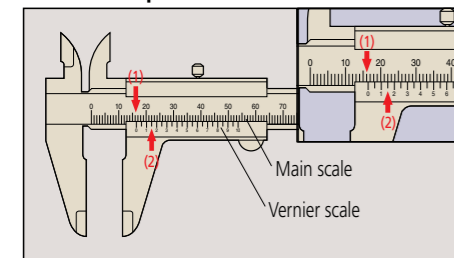

Graduation	0.05 mm
(1) Main scale	16 mm
(2) Vernier	0.15 mm
Reading	16.15 mm

Dial Calipers

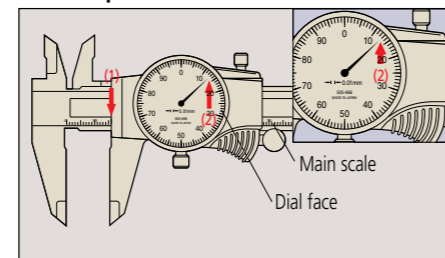

Graduation	0.01 mm
(1) Main scale	16 mm
(2) Dial face	0.13 mm
Reading	16.13 mm

Note: Above left, 0.15 mm (2) is read at the position where a main scale graduation line corresponds with a vernier graduation line.

Measurement examples

Outside measurement

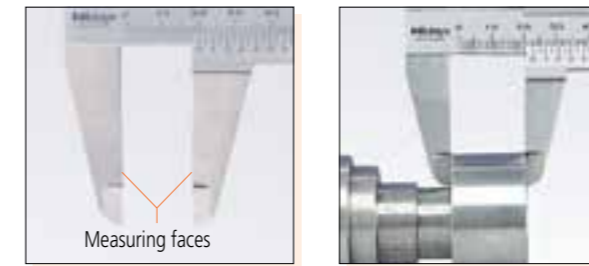

Inside measurement

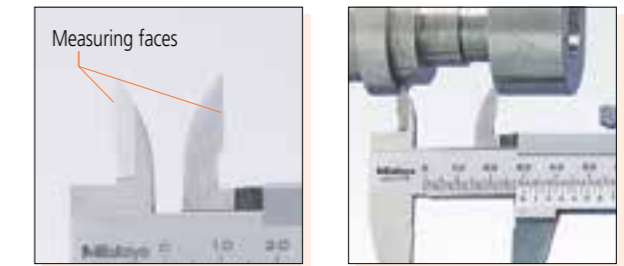

Step measurement

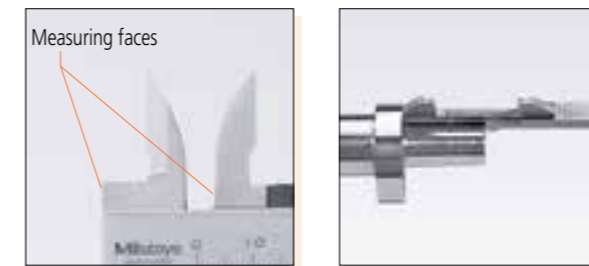

Depth measurement

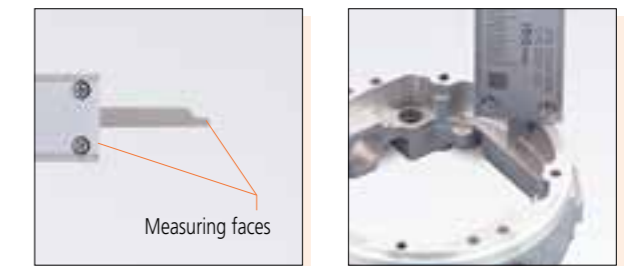

Special Purpose Caliper Applications

Point jaw type

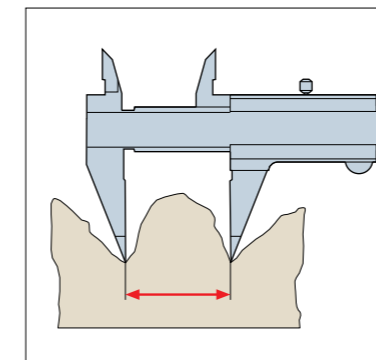

For uneven surface measurement

Offset jaw type

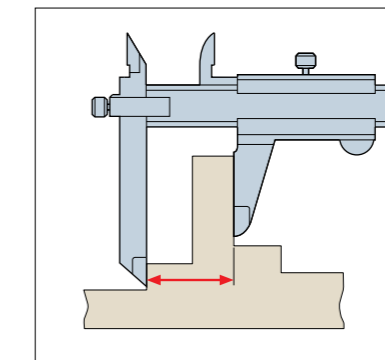

For stepped feature measurement

Depth type

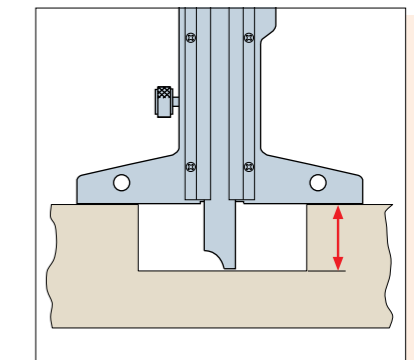

For depth measurement

Blade jaw type

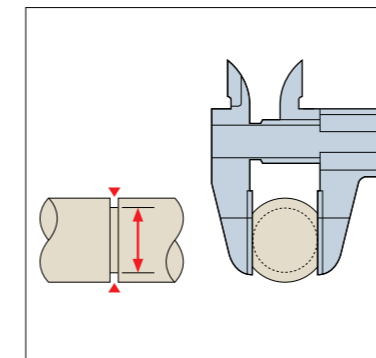

For diameter of narrow groove measurement

Neck type

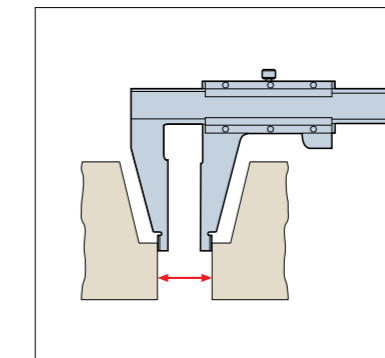

For outside diameter measurement such as thickness of recess

Tube Thickness type

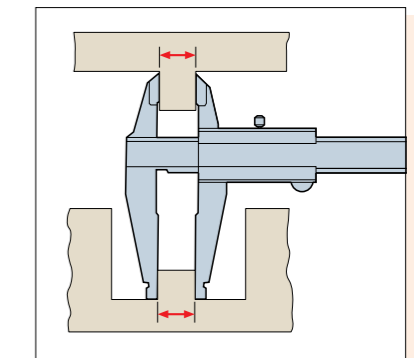

For pipe thickness measurement

Calipers

Vernier scale

This is a short auxiliary scale that enables accurate interpolation between the divisions of a longer scale without using mechanical magnification. The principle of operation is that each vernier scale division is slightly smaller than a main scale division, so that successive vernier graduations successively coincide with main scale graduations as one is moved relative to the other. Specifically, n divisions on a vernier scale are the same length as $n-1$ divisions on the main scale it works with, and n defines the division (or interpolation) ratio. Although n may be any number, in practice it is typically 10, 20, 25, etc., so that the division is a useful decimal fraction. The example below is for $n = 10$. The main scale is graduated in mm, and so the vernier scale is 9 mm (10 divisions) long, the same as 9 mm (9 divisions) on the main scale. This produces a difference in length of 0.1 mm (1) as shown in figure A (the 1st vernier graduation is aligned with the first main scale graduation). If the vernier scale is slid 0.1 mm to the right as shown in figure B, the 2nd graduation line on the vernier scale moves into alignment with the 2nd line on the main scale (2), and so enables easy reading of the 0.1 mm displacement.

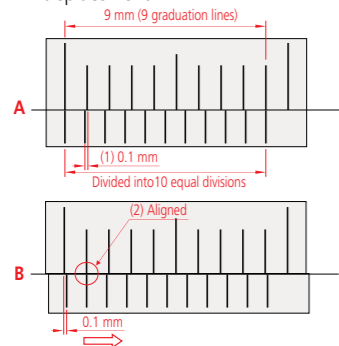

Some early calipers divided 19 divisions on the main scale by 20 vernier divisions to provide 0.05 mm resolution. However, the closely spaced lines proved difficult to read and so, since the 1970s, a long vernier scale that uses 39 main scale divisions to spread the lines is generally used instead, as shown below.

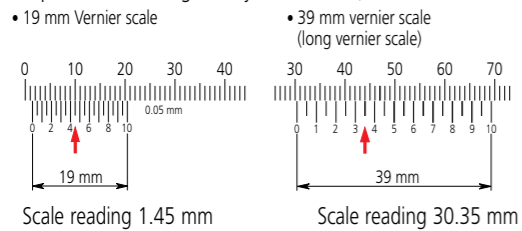

Calipers were made that gave an even finer resolution of 0.02 mm. These required a 49-division vernier scale dividing 50 main scale divisions. However, they were difficult to read and are now hard to find since digital calipers with an easily read display and resolution of 0.01 mm appeared.

About Long Calipers

Steel rules are commonly used to roughly measure large workpieces but if a little more accuracy is needed then a long caliper is suitable for the job. A long caliper is very convenient for its user friendliness but does require some care in use. In the first place it is important to realize there is no relationship between resolution and accuracy. For details, refer to the values in our catalog. Resolution is constant whereas the accuracy obtainable varies dramatically according to how the caliper is used.

The measuring method with this instrument is a concern since distortion of the main beam causes a large amount of the measurement error, so accuracy will vary greatly depending on the method used for supporting the caliper at the time. Also, be careful not to use too much measuring force when using the outside measuring faces as they are furthest away from the main beam so errors will be at a maximum here. This precaution is also necessary when using the tips of the outside measuring faces of a long-jaw caliper.

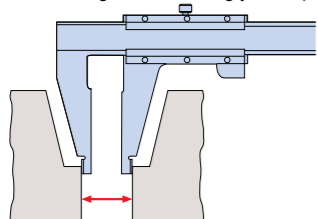

Small hole measurement with an M-type caliper

A structural error d occurs when you measure the internal diameter of a small hole.

ϕD : True internal diameter
 ϕd : Measured diameter
 t_1, t_2 : Thickness of the inside jaw
 C : Distance between the inside jaws
 Δd : Measurement error ($\phi D - \phi d$)

True internal diameter (ϕD : 5 mm) Unit: mm	t_1+t_2+C	0.3	0.5	0.7
Δd	0.009	0.026	0.047	

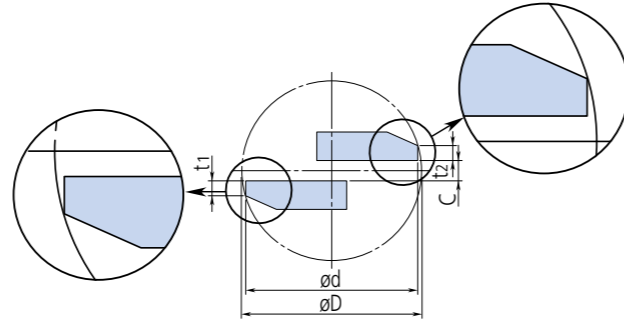

Inside Measurement with a CM-type Caliper

Because the inside measuring faces of a CM-type caliper are at the tips of the jaws the measuring face parallelism is heavily affected by measuring force, and this becomes a large factor in the measurement accuracy attainable. In contrast to an M-type caliper, a CM-type caliper cannot measure a very small hole diameter because it is limited to the size of the stepped jaws, although normally this is no inconvenience as it would be unusual to have to measure a very small hole with this type of caliper. Of course, the radius of curvature on the inside measuring faces is always small enough to allow correct hole diameter measurements right down to the lowest limit (jaw closure). Mitutoyo CM-type calipers are provided with an extra scale on the slider for inside measurements so they can be read directly without the need for calculation, just as for an outside measurement. This useful feature eliminates the possibility of error that occurs when having to add the inside-jaw-thickness correction on a single-scale caliper.

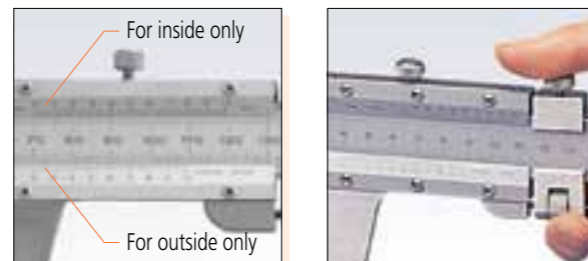

General notes on use of caliper

1. Potential causes of error

A variety of factors can cause errors when measuring with a caliper. Major factors include parallax effects, excessive measuring force due to the fact that a caliper does not conform to Abbe's Principle, differential thermal expansion due to a temperature difference between the caliper and workpiece, and the effect of the thickness of the knife-edge jaws and the clearance between these jaws during measurement of the diameter of a small hole. Although there are also other error factors such as graduation accuracy, reference edge straightness, main scale flatness on the main blade, and squareness of the jaws, these factors are included within the instrumental error tolerances. Therefore, these factors do not cause problems as long as the caliper satisfies the instrumental error tolerances. Handling notes have been added to the JIS so that consumers can appreciate the error factors caused by the structure of the caliper before use. These notes relate to the measuring force and stipulate that "as the caliper does not have a constant-force device, you must measure a workpiece with an appropriate even measuring force. Take extra care when you measure it with the root or tip of the jaw because a large error could occur in such cases."

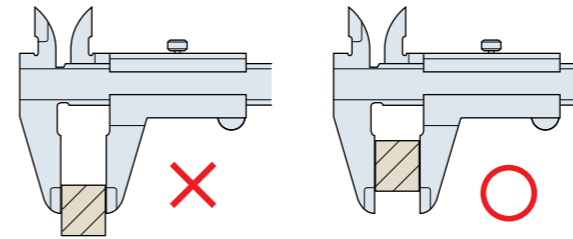
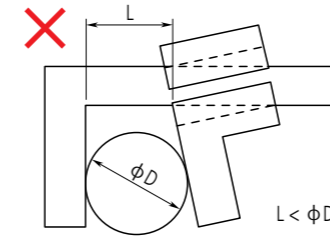

2. Inside measurement

Insert the inside jaw as deeply as possible before measurement. Read the maximum indicated value during inside measurement. Read the minimum indicated value during groove width measurement.

3. Depth measurement

Read the minimum indicated value during depth measurement.

4. Parallax error when reading the scales

Look straight at the vernier graduation line when checking the alignment of vernier graduation lines to the main scale graduation lines. If you look at a vernier graduation line from an oblique direction (A), the apparent alignment position is distorted by ΔX as shown in the figure below due to a parallax effect caused by the step height (H) between the planes of the vernier graduations and the main scale graduations, resulting in a reading error of the measured value. To avoid this error, the JIS stipulates that the step height should be no more than 0.3 mm.

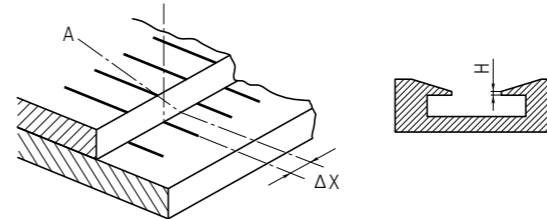

5. Moving Jaw Tilt Error

If the moving jaw becomes tilted out of parallel with the fixed jaw, either through excessive force being used on the slider or lack of straightness in the reference edge of the beam, a measurement error will occur as shown in the figure. This error may be substantial due to the fact that a caliper does not conform to Abbe's Principle.

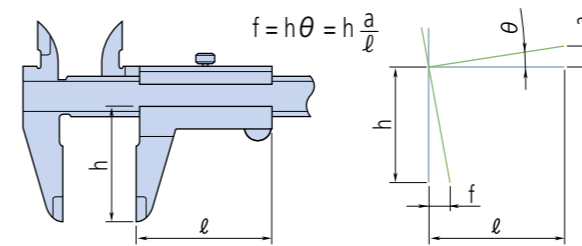

Example: Assume that the error slope of the jaws due to tilt of the slider is 0.01 mm in 50 mm and the outside measuring jaws are 40 mm deep, then the error (at the jaw tip) is calculated as $(40/50) \times 0.01 \text{ mm} = 0.008 \text{ mm}$. If the guide face is worn then an error may be present even using the correct measuring force.

6. Relationship between measurement and temperature

The main scale of a caliper is engraved (or mounted on) stainless steel, and although the linear thermal expansion coefficient is equal to that of the most common workpiece material, steel, i.e. $(10.2 \pm 1) \times 10^{-6} / \text{K}$, note that other workpiece materials, the room temperature and the workpiece temperature may affect measurement accuracy.

7. Handling

Caliper jaws are sharp, and therefore the instrument must be handled with care to avoid personal injury. Avoid damaging the scale of a digital caliper and do not engrave an identification number or other information on it with an electric marker pen. Avoid damaging a caliper by subjecting it to impact with hard objects or by dropping it on a bench or the floor.

8. Maintenance of beam sliding surfaces and measuring faces

Wipe away dust and dirt from the sliding surfaces and measuring faces with a dry soft cloth before using the caliper.

9. Checking and setting the origin before use

Clean the measuring surfaces by gripping a sheet of clean paper between the outside jaws and then slowly pulling it out. Close the jaws and ensure that the vernier scale (or display) reads zero before using the caliper. When using a Digimatic caliper, reset the origin (ORIGIN button) after replacing the battery.

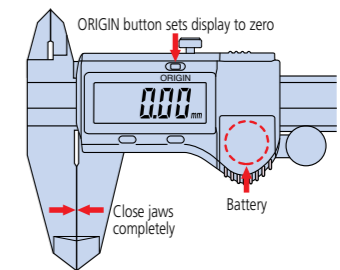

10. Handling after use

After using the caliper, completely wipe off any water and oil. Then, lightly apply anti-corrosion oil and let it dry before storage. Wipe off water from a waterproof caliper as well because it may also rust.

11. Notes on storage

Avoid direct sunlight, high temperatures, low temperatures, and high humidity during storage. If a digital caliper will not be used for more than three months, remove the battery before storage. Do not leave the jaws of a caliper completely closed during storage.

Performance evaluation method for the caliper

JIS B 7507 was revised and issued in 2016 as the Japanese Industrial Standards of the caliper, and the "Instrumental error" indicating the indication error of the caliper has been changed to "Maximum Permissible Error (MPE) of indication".

The "Instrumental error" of the conventional JIS adopts acceptance criteria that the specification range (precision specification) equals acceptance range, and the OK/NG judgment does not include measurement uncertainty. (Fig. 1) The "Maximum Permissible Error (MPE) of indication" of the new JIS adopts the basic concept of the OK/NG judgment taking into account the uncertainty adopted in the ISO standard (ISO 14253-1).

The verification of conformity and nonconformity to the specifications is clearly stipulated to use the internationally recognized acceptance criteria (simple acceptance) when the specification range equals the acceptance range, and it is accepted that the specification range equals the acceptance range if a given condition considering uncertainty is met.

In this case, the internationally recognized acceptance criterion is ISO/TR 14253-6:2012. (Fig. 2)

The following describes the standard inspection method including the revised content of JIS 2016.

Fig. 1 conventional JIS Instrumental error
JIS B 7507-1993

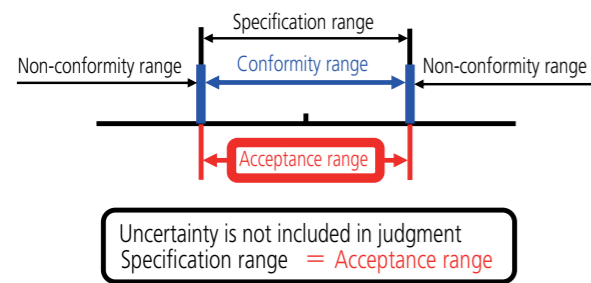
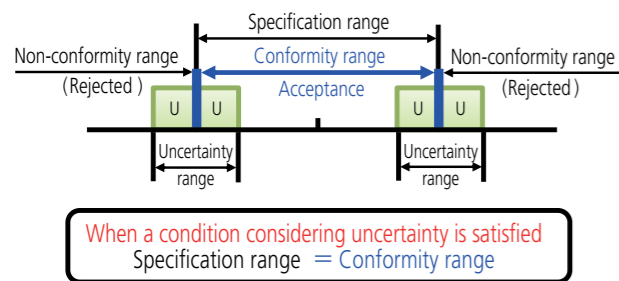

Fig. 2 New JIS Maximum Permissible Error (MPE)
JIS B 7507: 2016 (ISO/TR 14253-6: 2012)



Maximum Permissible Error of partial measuring surface contact error E_{MPE} [JIS B 7507:2016]

The partial measuring surface contact error of a caliper is an indication error applied to the outside measurement.

Table 1 shows the Maximum Permissible Error E_{MPE} of the indication value of the partial measuring surface contact error.

The value can be obtained by inserting a gauge block, or an equivalent or higher gauge, between the outside measuring surfaces (Fig. 3), measuring the different position along the jaw at an arbitrary position in the measuring range and then subtracting the dimension of the gage from the indicated value.

Scale Shift Error S_{MPE} [JIS B 7507: 2016]

The scale shift error in a caliper is an indication error of the inside measurement, depth measurement, etc., if measuring surfaces other than the outside measuring surfaces are used.

The Maximum Permissible Error S_{MPE} of the indication value for inside measurement is given in Table 1. The Maximum Permissible Error S_{MPE} of depth measurement is obtained by adding 0.02 mm to a value in Table 1.

The indication error for inside measurement can be obtained by using gauge blocks (or equivalent standards) and standard jaws from an accessory set to form accurate inside dimensions for calibration (Fig. 4), with the error being given by the indicated value minus the gauge block size.

Unit: mm

Measurement length	Scale interval, graduation or resolution	
	0.05	0.02
50 or less	± 0.05	± 0.02
Over 50, 100 or less	± 0.06	± 0.03
Over 100, 200 or less	± 0.07	
Over 200, 300 or less	± 0.08	± 0.04

Note: E_{MPE} includes the measurement error arising from the straightness, flatness and parallelism of the measuring surface.

Table 1: Maximum Permissible Error E_{MPE} of partial measuring surface contact error in a conventional caliper.

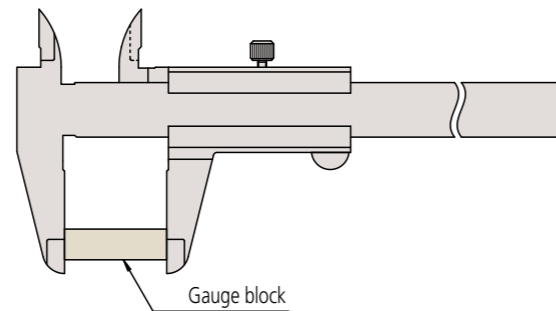

Fig. 3: Determining of partial measuring surface contact error

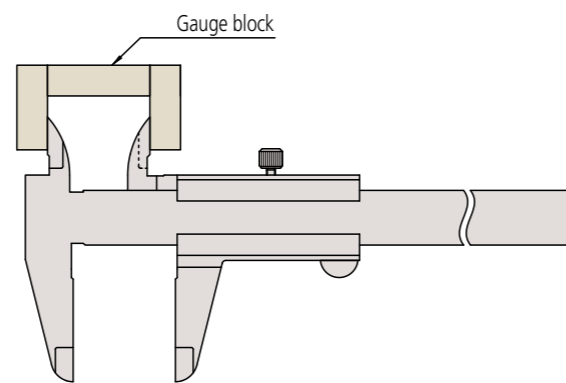

Fig. 4: Determining inside measurement indication error

Support for ISO 13385-1:2019

The ISO standard for calipers, ISO 13385-1, was revised and published as ISO 13385-1:2019 in August 2019. The major point of this revision is that it more specifically quantifies the notation and the inspection methods, etc. related to caliper accuracy. This quantification does not affect the quality of calipers manufactured in the past, as they were measured and inspected in an agreed, standardized way in line with certain methods and criteria. The following paragraphs explain points and changes in the revised ISO 13385-1:2019.

Partial surface contact error $E_{(MPE)}$

The partial surface contact error of a caliper is an indication error applied to outside measurement.

The ISO-2019 standard quantifies for each measuring range the testing method and criteria, such as test points, number of tests, and testing arrangement that were previously left to the manufacturers' own criteria.

(Fig. 1, Table 1)

Ex.) For a caliper with a measuring range of 150 mm, the revised standard requires five or more test points.

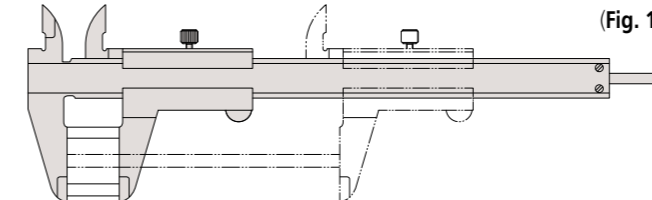

Number of partial surface contact error test points (Table 1)

Measuring range (mm)	Minimum number of test points
150	5
300	6
1000	7
1000 or more	8

Furthermore, the revised standards require testing in 90% or more points within the product measuring range as well as testing at the root and tip of the jaw at the maximum/minimum point. Therefore, it is important to conduct tests following the newly defined standard.

The following is an example of measurement for a 150 mm caliper. To comply with the ISO-2019 standard, the minimum number of test points is five for a 150 mm caliper. (Table 1)

Five or more test points are necessary to comply with the ISO-2019 standard. These include testing at the maximum and minimum point, as well as at the root and tip of the measuring unit. These test points must add up to a total of five.

Shift Error $S_{(MPE)}$

The Shift Error for calipers is the error of indication for areas other than the outside measuring face. In the ISO-2019 standard, all measurement errors (inside, depth, step, and I.D. measurement error) other than the outside measurement error ($E_{(MPE)}$) are Scale Shift Errors ($S_{(MPE)}$). Test points and their number were newly quantified as the type of errors included in the Scale Shift Error were better specified. (Fig. 2, 3, Table 3)

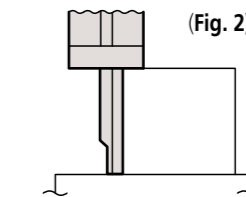

Scale Shift Error measurement example- depth measurement

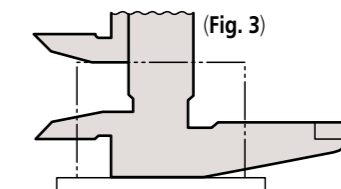

Scale Shift Error measurement example- step measurement

Ex.) Step and depth measurement [ISO 13385-1:2019] (Table 3)

Test numbering	Test point	Reference standard
1	Less than 50 mm	Gauge block

For example, for depth measurement or step measurement, the standard specifically requires one or more test points at less than 50 mm and a testing arrangement using gauge blocks. (See Table 3)

Height Gages

Nomenclature

Vernier Height Gage

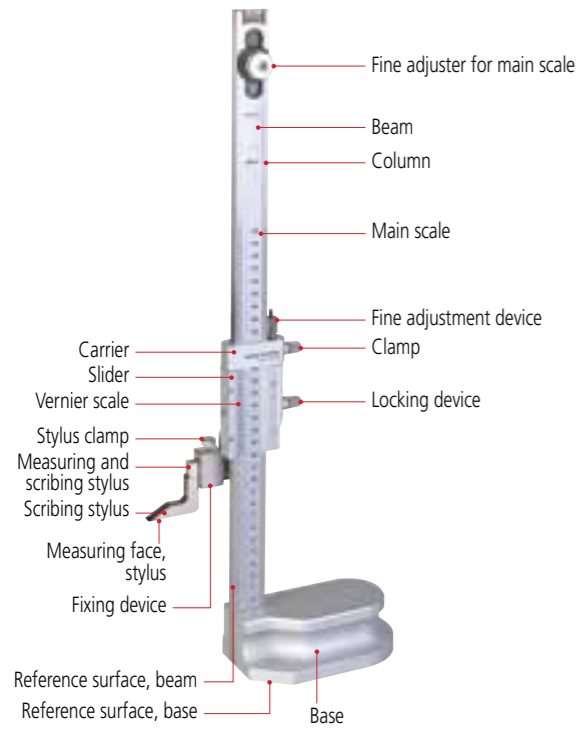

Mechanical Digit Height Gage

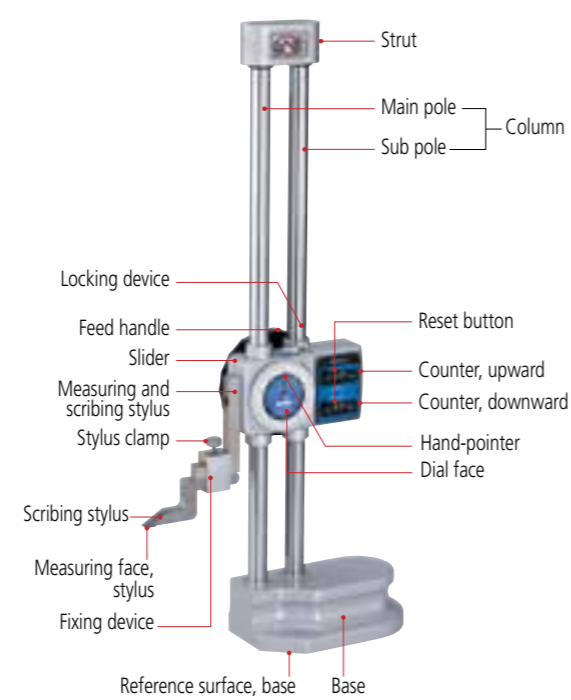

Digimatic Height Gages

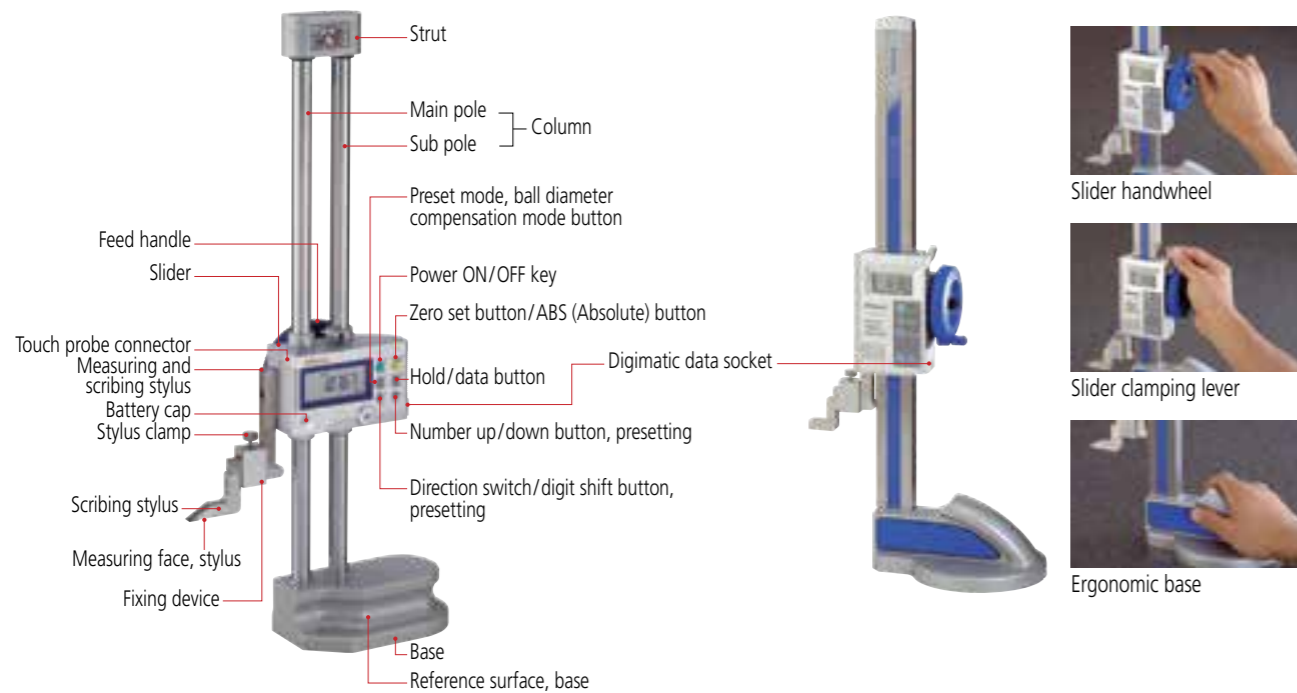

Height gage applications with optional accessories and other measuring tools



Test indicator attachment



Touch probe attachment

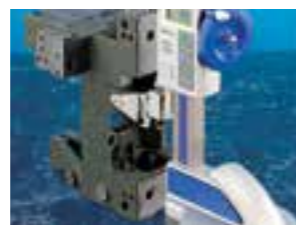

Center probe attachment



Depth gage attachment

How to read

Vernier Height gage

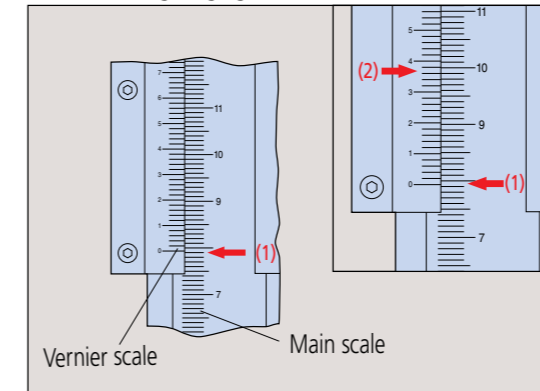

Graduation 0.02 mm

(1) Main scale	79.00 mm
(2) Vernier	0.36 mm
Reading	79.36 mm

Mechanical Digit Height gage Measuring upwards from a reference surface

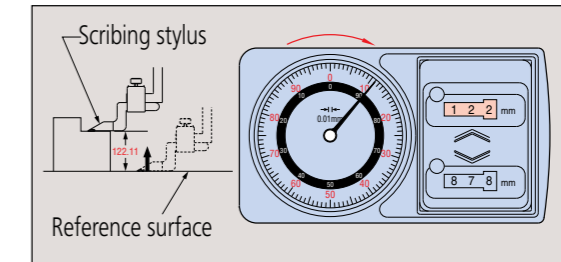

(1) Counter	122.00 mm
(2) Dial	0.11 mm
Reading	122.11 mm

Measuring downwards from a reference surface

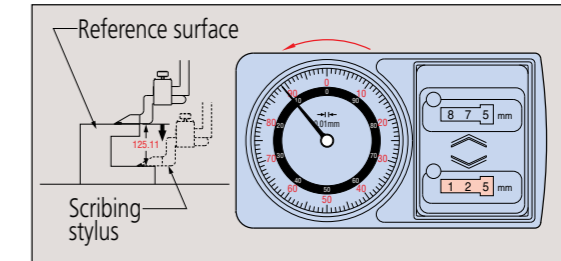

(1) Counter	125.00 mm
(2) Dial	0.11 mm
Reading	125.11 mm

General notes on use of Height Gages

1. Potential causes of error

Like the caliper, the error factors involved include parallax effects, error caused by excessive measuring force due to the fact that a height gage does not conform to Abbe's Principle, and differential thermal expansion due to a temperature difference between the height gage and workpiece. There are also other error factors caused by the structure of the height gage. In particular, the error factors related to a warped reference edge and scriber installation described below should be studied before use.

2. Reference edge (column) warping and scriber installation

Like the caliper, and as shown in the following figure, measurement errors result when using the height gage if the reference column, which guides the slider, becomes warped. This error can be represented by the same calculation formula for errors caused by nonconformance to Abbe's Principle. Installing the scriber (or a lever-type dial indicator) requires careful consideration because it affects the size of any error due to a warped reference column by increasing dimension h in the above formula. In other words, if an optional long scriber or lever-type dial indicator is used, the measurement error becomes larger.

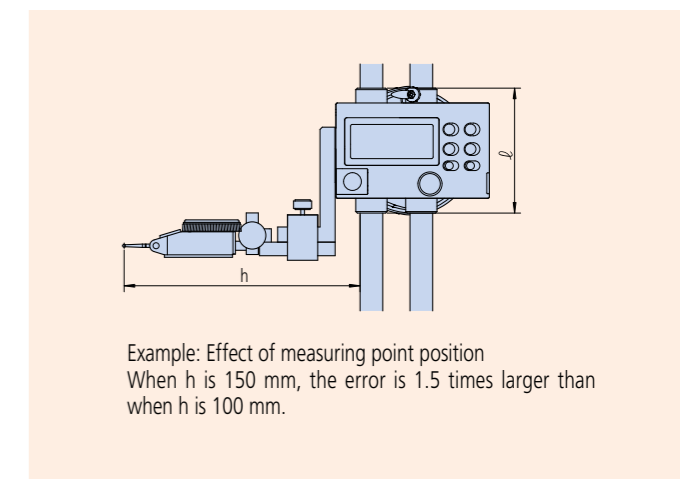
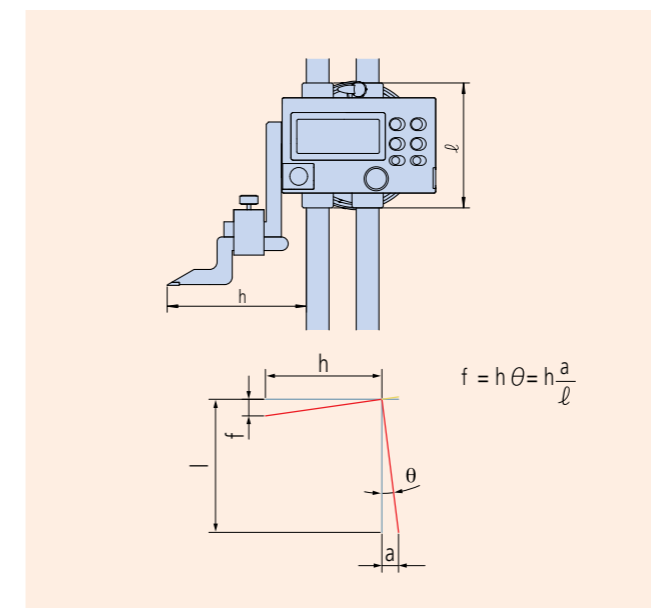

Height Gages

3. Lifting of the base from the reference surface

When setting the scriber height from a gauge block stack, or from a workpiece feature, the base may lift from the surface plate if excessive downwards force is used on the slider, and this results in measurement error. For accurate setting, move the slider slowly downwards while moving the scriber tip to and fro over the gauge block surface (or feature). The correct setting is when the scriber is just felt to lightly touch as it moves over the edge of the surface. It is also necessary to make sure that the surface plate and height gage base reference surface are free of dust or burrs before use.

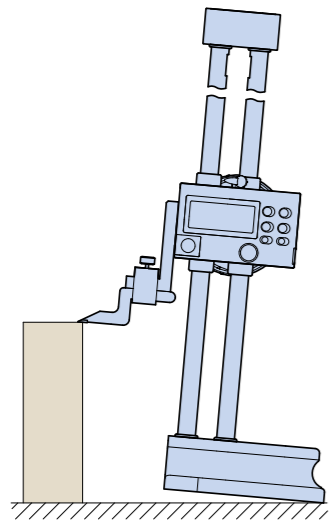

4. Error due to inclination of the main scale (column)

According to JIS standards, the perpendicularity of the column reference edge to the base reference surface should be better than:

$$\left(0.01 + \frac{L}{1000}\right) \text{ mm} \quad L \text{ indicates the measuring length (unit: mm)}$$

This is not a very onerous specification. For example, the perpendicularity limit allowable is 0.61 mm when L is 600 mm. This is because this error factor has a small influence and does not change the inclination of the slider, unlike a warped column.

5. Relationship between accuracy and temperature

Height gages are made of several materials. Note that some combinations of workpiece material, room temperature, and workpiece temperature may affect measuring accuracy if this effect is not allowed for by performing a correction calculation.

6. The tip of a height gage scriber is very sharp and must be handled carefully if personal injury is to be avoided.

7. Do not damage a digital height gage scale by engraving an identification number or other information on it with an electric marker pen.

8. Carefully handle a height gage so as not to drop it or bump it against anything.

Notes on using the height gage

1. Keep the column, which guides the slider, clean. If dust or dirt accumulates on it, sliding becomes difficult, leading to errors in setting and measuring.
2. When scribing, securely lock the slider in position using the clamping arrangements provided. It is advisable to confirm the setting after clamping because the act of clamping on some height gages can alter the setting slightly. If this is so, allowance must be made when setting to allow for this effect.
3. Parallelism between the scriber measuring face and the base reference surface should be 0.01 mm or better. Remove any dust or burrs on the mounting surface when installing the scriber or lever-type dial indicator before measurement. Keep the scriber and other parts securely fixed in place during measurement.
4. If the main scale of the height gage can be moved, move it as required to set the zero point, and securely tighten the fixing nuts.
5. Errors due to parallax error are not negligible. When reading a value, always look straight at the graduations.
6. Handling after use: Completely wipe away any water and oil. Lightly apply a thin coating of anti-corrosion oil and let dry before storage.
7. Notes on storage: Avoid direct sunlight, high temperatures, low temperatures, and high humidity during storage. If a digital height gage will not be used for more than three months, remove the battery before storage. If a protective cover is provided, use the cover during storage to prevent dust from adhering to the column.

Height Gage Performance Evaluation Method

JIS B 7517 was revised and issued in 2018 as the Japanese Industrial Standards of the height gage, and the "Instrumental error" indicating the indication error of the height gage has been changed to "Maximum Permissible Error (MPE) of indication".

The "Instrumental error" of the conventional JIS adopts acceptance criteria that the specification range (precision specification) equals acceptance range, and the OK/NG judgment does not include measurement uncertainty (Fig. 1). The "Maximum Permissible Error (MPE) of indication" of the new JIS employs the basic concept of the OK/NG judgment taking into account the uncertainty adopted in the ISO standard (ISO 14253-1).

The verification of conformity and nonconformity to the specifications is clearly stipulated to use the internationally recognized acceptance criteria (simple acceptance) when the specification range equals the acceptance range, and it is accepted that the specification range equals the acceptance range if a given condition considering uncertainty is met.

The above said internationally recognized acceptance criterion is ISO/TR 14253-6: 2012 (Fig. 2).

The following describes the standard inspection method including the revised content of JIS 2018.

Fig. 1 **conventional** Instrumental error

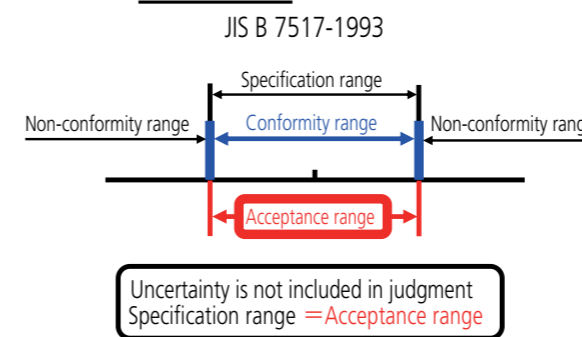
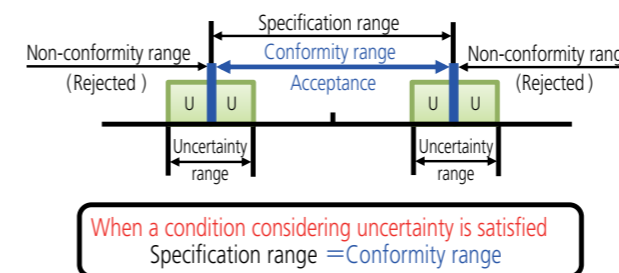

Fig. 2 **New JIS** Maximum Permissible Error (MPE)

JIS B 7517: 2018 (ISO/TR 14253-6: 2012)



Maximum Permissible Error of height measurement E_{MPE} [JIS B 7517: 2018]

The height measurement error in a height gage is the indication error when the reference edge (column) is perpendicular to the base reference surface and the direction of contact is downward. Table 1 shows the maximum permissible height measurement error E_{MPE} .

E_{MPE} for any desired height is obtained by measuring a gauge block, or equivalent, with a height gage on a precision surface plate (Fig. 3) and then subtracting the gauge block size from the measured size.

Table 1: Maximum permissible height measurement error E_{MPE} of a conventional height gage

Unit: mm

Measurement height	Scale interval, graduation or resolution	
	0.05	0.02 or 0.01
50 or less	±0.05	±0.02
Over 50, 100 or less	±0.06	±0.03
Over 100, 200 or less	±0.07	
Over 200, 300 or less	±0.08	±0.04
Over 300, 400 or less	±0.09	
Over 400, 500 or less	±0.10	±0.05
Over 500, 600 or less	±0.11	
Over 600, 700 or less	±0.12	±0.06
Over 700, 800 or less	±0.13	
Over 800, 900 or less	±0.14	±0.07
Over 900, 1000 or less	±0.15	

Note: E_{MPE} includes the measurement error arising from straightness, flatness of the measuring surface and parallelism with the reference surface.

Fig. 3: Determination of height measurement error

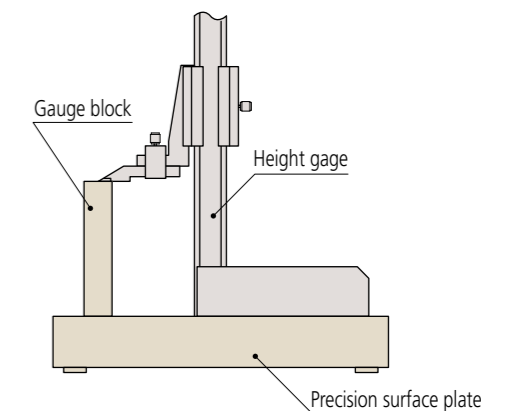

The "Instrumental error" indicating the indication error of JIS has been changed to "Maximum Permissible Error (MPE) of indication" for the following models:

- 192 Series Digimatic Height Gage described on page D-43 (All models)
- 570 Series ABSOLUTE Digimatic Height Gage described on page D-45 (All models)
- 570 Series Digimatic Height Gage described on page D-47 (All models)
- 514, 506 Series Standard Height Gage with Adjustable Main Scale described on page D-49 (All models)
- 192 Series With digital counter described on page D-50 (All models)

Depth Gages

Depth Gage Performance Evaluation Method

JIS B 7518 was revised and issued in 2018 as the Japanese Industrial Standards of the depth gage, and the "Instrumental error" indicating the indication error of the depth gage has been changed to "Maximum Permissible Error (MPE) of indication".

The "Instrumental error" of the conventional JIS adopts acceptance criteria that the specification range (precision specification) equals acceptance range, and the OK/NG judgment does not include measurement uncertainty (Fig. 1). The "Maximum Permissible Error (MPE) of indication" of the new JIS employs the basic concept of the OK/NG judgment taking into account the uncertainty adopted in the ISO standard (ISO 14253-1).

The verification of conformity and nonconformity to the specifications is clearly stipulated to use the internationally recognized acceptance criteria (simple acceptance) when the specification range equals the acceptance range, and it is accepted that the specification range equals the acceptance range if a given condition considering uncertainty is met.

The above said internationally recognized acceptance criterion is ISO/TR 14253-6: 2012 (Fig. 2).

The following describes the standard inspection method including the revised content of JIS 2018.

Fig. 1 conventional Instrumental error
JIS B 7518-1993

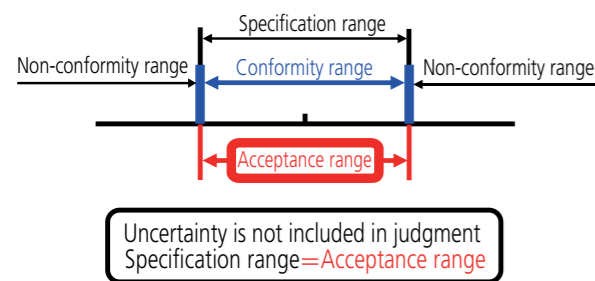
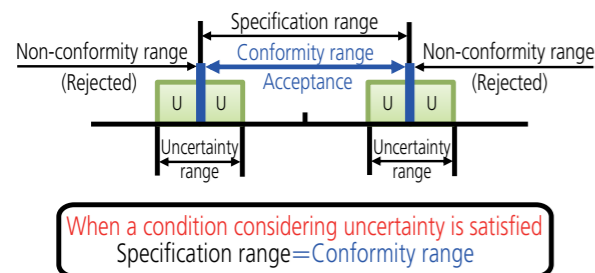

Fig. 2 New JIS Maximum Permissible Error (MPE)
JIS B 7518: 2018 (ISO/TR 14253-6: 2012)



Maximum Permissible Error of depth measurement E_{MPE} [JIS B 7518: 2018]

The Maximum Permissible Error E_{MPE} of a depth gage is an indication error applied to depth measurement.

Table 1 shows the Maximum Permissible Error E_{MPE} of the indication value of the partial measuring surface contact error.

E_{MPE} for any desired height is obtained by measuring the height of two equal length gauge blocks, or equivalent, with a height gage on a precision surface plate (Fig. 3) and then subtracting the gauge block size from the measured size.

Table 1: Maximum permissible error E_{MPE} of partial measuring face contact of a conventional depth gage

Measurement depth	Scale interval, graduation or resolution	
	0.05	0.02 or 0.01
50 or less	± 0.05	± 0.02
Over 50, 100 or less	± 0.06	± 0.03
Over 100, 200 or less	± 0.07	
Over 200, 300 or less	± 0.08	± 0.04
Over 300, 400 or less	± 0.09	
Over 400, 500 or less	± 0.10	± 0.05
Over 500, 600 or less	± 0.11	

Unit: mm

Note: E_{MPE} includes the measurement error arising from straightness, flatness of the measuring surface and parallelism with the reference surface.

Fig. 3: Determination of partial measuring face contact

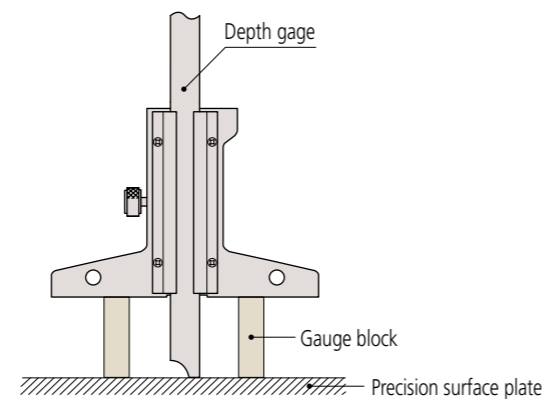

The "Instrumental error" indicating the indication error of JIS has been changed to "Maximum Permissible Error (MPE) of indication" for the following models:

- 571 Series ABSOLUTE Digimatic Depth Gage described on page D-64 (All models)
- 527 Series Vernier Depth Gage described on page D-65 (All models)
- 527, 571 Series Hook End Type described on page D-66 (All models)
- 571 Series Mini Depth Gage described on page D-67 (All models)

Gauge Blocks

Definition of the Meter

The 17th General Conference of Weights and Measures in 1983 decided on a new definition of the meter unit as the length of the path traveled by light in a vacuum during a time interval of 1/299 792 458 of a second. The gauge block is the practical realization of this unit and as such is used widely throughout industry.

Selection, Preparation and Assembly of a Gauge Block Stack

Select gauge blocks to be combined to make up the size required for the stack.

- Take the following things into account when selecting gauge blocks.
 - Use the minimum number of blocks whenever possible.
 - Select thick gauge blocks whenever possible.
 - Select the size from the one that has the least significant digit required, and then work back through the more significant digits.
- Clean the gauge blocks with an appropriate cleaning agent.
- Check the measuring faces for burrs by using an optical flat as follows:

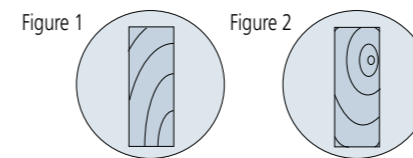

- Wipe each measuring face clean.
- Gently place the optical flat on the gauge block measuring face.
- Lightly slide the optical flat until interference fringes appear.
 - Judgment 1: If no interference fringes appear, it is assumed that there is a large burr or contaminant on the measuring face.
 - Judgment 2: If the interference fringes disappear, no burr exists on the measuring face.
 - Judgment 3: If some interference fringes remain locally while the flat is gently moved to and fro, a burr exists on the measuring face. If the fringes move along with the optical flat, there is a burr on the optical flat.
- Remove burrs, refer to the figures below for procedures.

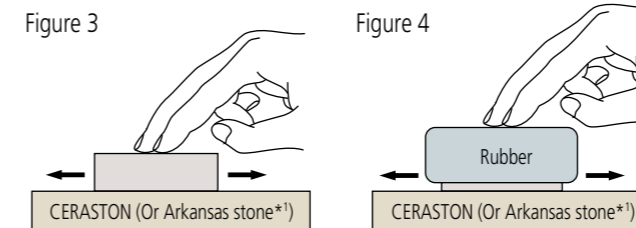

- Wipe any dust and oil films from the gauge block and the Ceraston (or Arkansas stone) using a solvent.
- Place the gauge block on the Ceraston so that the measuring face that has burrs is on the abrasive surface of the stone. While applying light pressure, move the gauge block to and fro about ten times (Fig. 3). Use a block rubber for thin gauge blocks to apply even pressure (Fig. 4).
- Check the measuring face for burrs with an optical flat. If the burrs have not been removed, repeat step (2). If burrs are too large, they may not be removed with an abrasive stone. If so, discard the gauge block.

*1 Mitutoyo does not offer Arkansas stones.

- Apply a very small amount of oil to the measuring face and spread it evenly across the face. (Wipe the face until the oil film is almost removed.) Grease, spindle oil, vaseline, etc., are commonly used.

- Gently overlay the faces of the gauge blocks to be wrung together. There are three methods to use (a, b and c as shown below) according to the size of blocks being wrung:

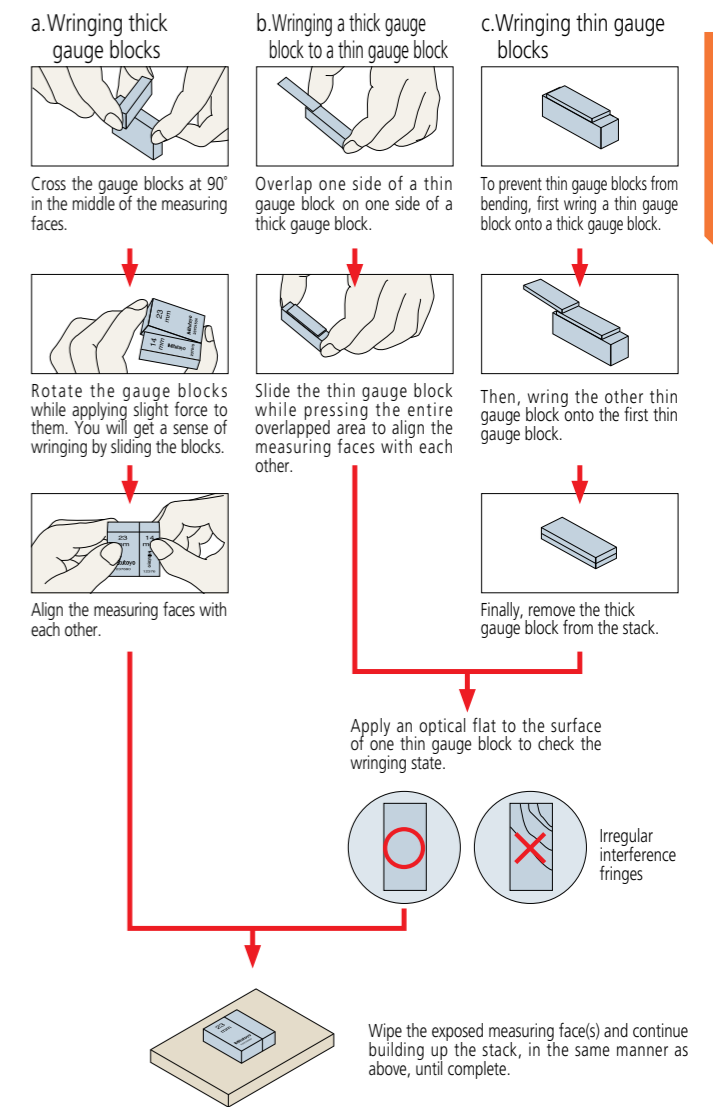

Thermal Stabilization Time

The following figure shows the degree of dimensional change when handling a 100 mm steel gauge block with bare hands.

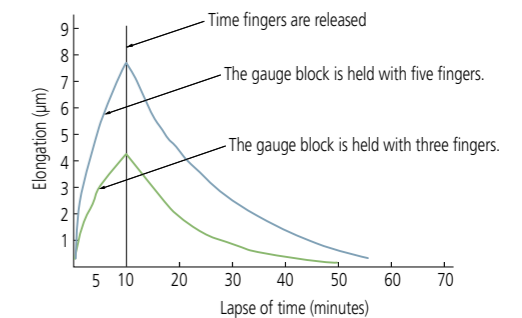

Dial Indicators, Digital Indicators and Test Indicators

Nomenclature



Measuring orientation

	Position	Remarks
Vertical position (contact point downward)		—
Lateral position (spindle horizontal)		If measurement is performed in the lateral orientation, or upside-down orientation, the measuring force is less than in the vertical orientation. In this case be sure to check the operation and repeatability of the indicator. For guaranteed-operation specifications according to the operating orientation refer to the specific product descriptions in the catalog.
Upside-down position (contact point upward)		

Mounting a Dial gage

Stem mounting	Method		
	Note	<ul style="list-style-type: none"> Mounting hole tolerance: $\phi 8G7 (+0.005 \text{ to } 0.02)$ Clamping screw: M4 to M6 Clamping position: 8 mm or more from the lower edge of the stem Maximum clamping torque: 150 N-cm when clamping with a single M5 screw Note that excessive clamping torque may adversely affect spindle movement. 	<ul style="list-style-type: none"> Mounting hole tolerance: $\phi 8G7 (+0.005 \text{ to } 0.02)$
Lug mounting	Method		
	Note	<ul style="list-style-type: none"> Lugs can be changed 90° in orientation according to the application. (The lug is set horizontally when shipped.) Lugs of some Series 1 models (No. 1911A-10, 1913A-10 and 1003A), however, cannot be altered to horizontal. To avoid cosine-effect error, ensure that any type of gage or indicator is mounted with its spindle in line with the intended measurement direction. 	

Setting the origin of a digital indicator

The accuracy specification in the range of 0.2 mm from the end of the stroke is not guaranteed for Digimatic indicators. When setting the zero point or presetting a specific value, be sure to lift the spindle at least 0.2 mm from the end of the stroke.

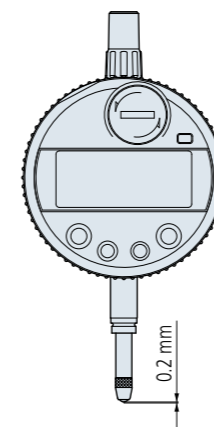

Contact point

- Screw thread is standardized on M2.5 x 0.45 (Length: 5 mm).
- Incomplete thread section at the root of the screw shall be less than 0.7 mm when fabricating a contact point.

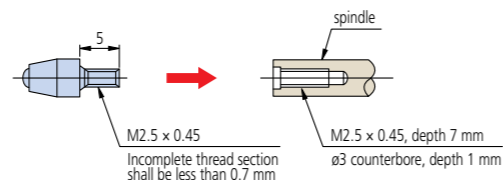

Care of the spindle

- Do not lubricate the spindle. Doing so might cause dust to accumulate, resulting in a malfunction.
- If the spindle movement is poor, wipe the upper and lower spindle surfaces with a dry or alcohol-soaked cloth. If the movement is not improved by cleaning, contact Mitutoyo for repair.
- Before making a measurement or calibration, confirm if the spindle moves upward and downward smoothly, and stability of the zero point.

Dial Indicators, Digital Indicators and Test Indicators

Dial Indicator Standard B7503 : 2017 (Extract from JIS/Japanese Industrial Standards)

Item	Model	Measuring method (zero-point fixed)	Evaluation method (performance evaluation by moving the zero point)	Measurement examples
Indication error	One-revolution dial indicator and multi-revolution dial indicator	Indication error over the entire measuring range	Set the dial indicator on the supporting stand, and read the indication error*1 of the next point while gradually retracting the spindle.	
		1/10 revolution indication error	- Every 1/10 revolution for the first two revolutions*2 - Every half revolution from two to five revolutions	
	Multi-revolution dial indicator	1/2 revolution indication error	- Every revolution from five to ten revolutions - Every five revolutions from 10 to 50 revolutions	
		1 revolution indication error	- Every ten revolutions after 50 revolutions Next, after retracting the spindle for more than three graduations of the long hand, extend the spindle gradually and read the indication error at the same measurement point in the retract direction.	
Retrace error	One-revolution dial indicator and multi-revolution dial indicator		Obtain the maximum difference of all the measuring points in reference to the indication error at the same measuring point in both forward and backward directions.	
Repeatability			Set the dial indicator on the supporting stand, retract the spindle at a desired position within the measuring range. Then, extend the spindle quickly and slowly five times and read each value.	
Measuring force	One-revolution dial indicator and multi-revolution dial indicator		Set the dial indicator on the supporting stand, retract and extend the spindle continuously and gradually, and read the measuring force at the zero and end points.	

*1: For how to read the indication error, either read the input quantity of the measuring instrument aligning the long hand to the graduation, or read the indication value of the dial indicator according to the moving amount of the measuring instrument.
 *2: With the one-revolution dial indicator, read the indication error per 10 graduations.
 *3: With the one-revolution dial indicator, obtain the maximum difference of the indication error in the interval of adjacent 10 graduations.

Maximum permissible error

Graduation (mm)	Maximum permissible error (MPE) by measurement characteristics -- dial indicators with bezel dia. 50 mm or larger											Maximum permissible error (MPE) by measurement characteristics -- dial indicators with bezel dia. 50 mm or smaller and Back Plunger type dial indicators										
	0.01								0.005			0.001			0.01			0.005		0.002		0.001
Measuring range (mm)	1 or less	Over 1 and up to 3	Over 3 and up to 5	Over 5 and up to 10	Over 10 and up to 20	Over 20 and up to 30	Over 30 and up to 50	Over 50 and up to 100	5 or less	1 or less	Over 1 and up to 2	Over 2 and up to 5	1 or less	Over 1 and up to 3	Over 3 and up to 5	Over 5 and up to 10	5 or less	1 or less	1 or less			
Retrace error	3	3	3	3	5	7	8	9	3	2	2	3	4	4	4	5	3.5	2.5	2			
Repeatability	3	3	3	3	4	5	5	5	3	0.5	0.5	1	3	3	3	3	3	1	1			
Indication error	Arbitrary 1/10 revolution	5	5	5	5	8	10	10	12	5	2	2	3.5	8	8	8	9	6	2.5	2.5		
	Arbitrary 1/2 revolution	8	8	9	9	10	12	12	17	9	3.5	4	5	11	11	12	12	9	4.5	4		
	Arbitrary One revolution	8	9	10	10	15	15	15	20	10	4	5	6	12	12	14	14	10	5	4.5		
	Entire measuring range	8	10	12	15	25	30	40	50	12	5	7	10	15	16	18	20	12	6	5		

Note 1: The maximum permissible error (MPE) for one-revolution dial indicators does not specify the indication error of an arbitrary 1/2 and 1 revolution.
 Note 2: The MPE represents the value at 20 °C, which JIS B 0680 defines as the standard temperature.
 Note 3: The measurement characteristics of a dial indicator have to meet both maximum permissible error (MPE) and measurement force permissible limits (MPL) at any position within the measuring range in any posture when the measurement characteristics are not specified by the manufacturer.

Mitutoyo's Response to Dial Indicator Standard B 7503 : 2017

- We guarantee the accuracy of completed products by inspecting them in the vertical posture. Standard-attached inspection certificate includes inspection data.
- We issue paid-for inspection certificates for horizontal or opposite posture if required.
- It is said that, for evaluation of the compatibility to the specifications, JIS B 0641-1 or the criteria where the internationally-recognized specification range and the OK range are equal shall be applied. Also, it is said that the uncertainty is preferred to be evaluated based on ISO 14253-2 and ISO / IEC Guide 98-3. Therefore, we perform shipping inspection of dial indicators inclusive of the uncertainty of calibration as in the past.

Lever-operated dial indicator Standard B7533 : 2015 (Extract from JIS/Japanese Industrial Standards)

No.	Item.	Measuring method	Measuring point	Evaluation method	Diagram
1	Indication error over the entire measuring range (in the forward direction)	Holding the dial test indicator (lever type), define the reference point at near the contact point resting point where the indication and error of indication is set zero.	Per 10 graduations in the forward and backward direction from the reference point to the end point.	Obtain the difference between the maximum and the minimum values of indication error of all measurement points in the forward direction.	
2	10 graduations indication error	Then, move the contact point in the forward direction and read the error of indication at each measuring point.		In the forward direction from the reference point to the end point, obtain the maximum difference of the indication error among the adjacent measurement points per 10 graduations.	
3	1 revolution indication error	Next, after moving the contact point for more than three graduations from the end of the measuring range, move the contact point in the backward direction and read the error of indication at the same measurement point in the forward direction.		In the forward direction from the reference point to the end point, obtain the maximum difference of the maximum and the minimum indication errors to be read by the zero-point fixed method over the measuring range per 1 revolution.	
4	Retrace error	(The forward direction is the direction against the measuring force to the contact point of the lever-operated dial indicator; the backward direction is the measuring force applied direction.)		Obtain the maximum difference in reference to the indication error at the same measuring point in both forward and backward directions among all the measurement points.	
5	Repeatability	Holding the dial test indicator (lever type) with its stylus parallel with the top face of the measuring stage, move the contact point quickly and slowly five times at a desired position within the measuring range and read the indication at each point.		Obtain the maximum difference of the five measured values.	
6	Measuring force	Holding the dial test indicator (lever type), move the contact point in the forward and backward directions continuously and gradually, and read the measuring force in the measuring range.		Reference point and end point within the measuring range	

Maximum permissible error and permissible limits

Graduation (mm)	0.001/0.002			0.01			
	1 revolution	Multi-revolution		1 revolution		Multi-revolution	
Measuring range (mm)	0.3 or less	Over 0.3, up to 0.5	Over 0.5, up to 0.6	0.5 or less	Over 0.5, up to 1.0	Over 1.0, up to 1.6	
Error of indication over a range of	Measuring range (µm)	4	6	7	6	L1 ≤ 35	35 < L1
	One revolution (µm)	—	5	5	—	—	10
	10 scale divisions (µm)	2	2	2	5	5	5
Retrace error (µm)	3	4	4	4	4	5	5
Repeatability (µm)	1	1	1	3	3	3	3
Measuring force (N)	Max.	0.5	0.5	0.5	0.5	0.5	0.5
	Min.	0.01	0.01	0.01	0.01	0.01	0.01

Dial Indicators, Digital Indicators and Test Indicators

Dial Test Indicators and the Cosine Effect

Always minimize the angle between movement directions during use.

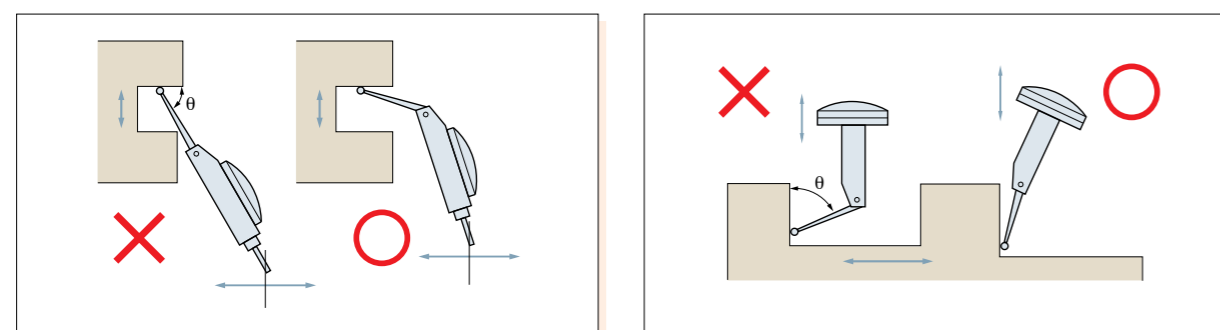
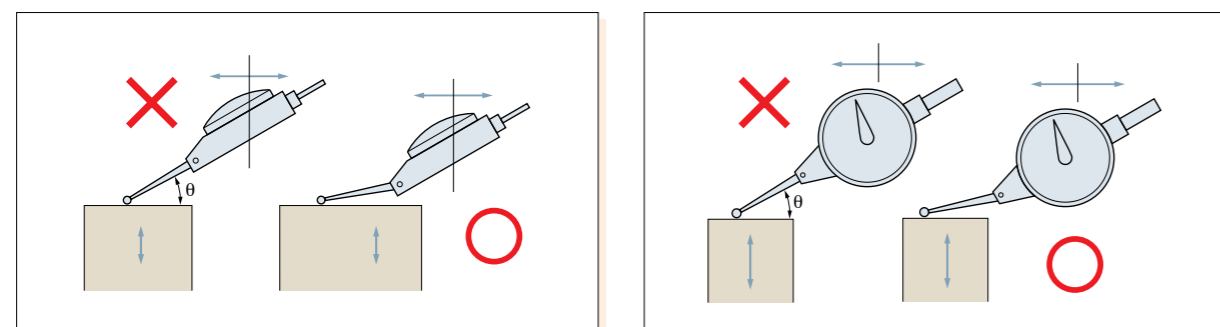
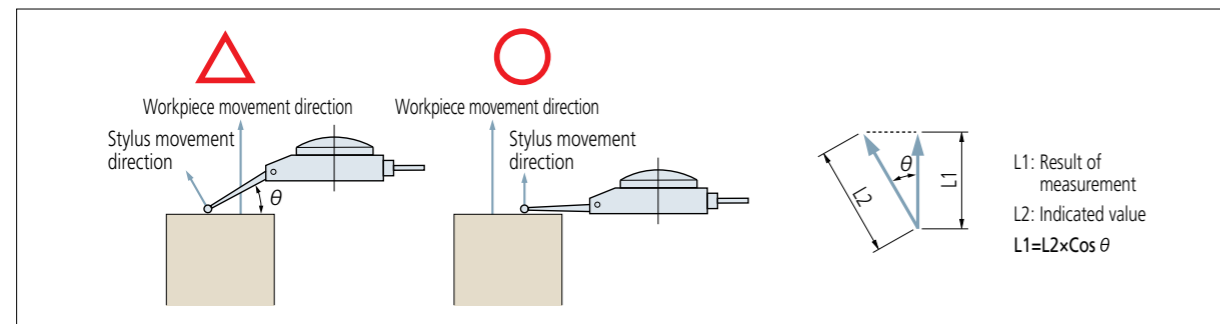

The reading of any indicator will not represent an accurate measurement if its measuring direction is misaligned with the intended direction of measurement (cosine effect). Because the measuring direction of a dial test indicator is at right angles to a line drawn through the contact point and the stylus pivot, this effect can be minimized by setting the stylus to minimize angle θ (as shown in the figures). If necessary, the dial reading can be compensated for the actual θ value by using the table below to give the result of measurement.

Result of measurement = indicated value x compensation value

Compensating for a non-zero angle

Examples

If a 0.002 mm measurement is indicated on the dial at various values of θ , the result of measurements are:
For $\theta = 10^\circ$, $0.002 \text{ mm} \times 0.98 = 0.00196 \text{ mm}$
For $\theta = 20^\circ$, $0.002 \text{ mm} \times 0.94 = 0.00188 \text{ mm}$
For $\theta = 30^\circ$, $0.002 \text{ mm} \times 0.87 = 0.00174 \text{ mm}$

Angle	Compensation value
10°	0.98
20°	0.94
30°	0.87
40°	0.77
50°	0.64
60°	0.50

Mitutoyo's Response to Lever-operated Dial Indicator B 7533 : 2015

- In the finished product inspection, the accuracy is guaranteed using the horizontal, tilted, vertical type dial indicator with its dial face facing upward; the parallel type with its dial face set in the vertical orientation. Standard-attached inspection certificate includes inspection data.
- The inspection certificate for other than the above postures is available for a fee.
- It is said that, for evaluation of the compatibility to the specifications, the criteria based on JIS B 0641-1 or ISO/TR14253-6 shall be applied. Also, it is said that the uncertainty is preferred to be evaluated based on ISO 14253-2 and ISO/IEC Guide 98-3. Therefore, we perform shipping inspection of dial indicators inclusive of the uncertainty of calibration as in the past.
- For universal and pocket types, we perform the finished product inspection based on JIS B 7533-1990.

Linear Gages

Head

Plain Stem and Stem with Clamp Nut

The stem used to mount a linear gage head is classified as a "plain type" or "clamp nut type" as illustrated below. The clamp nut stem allows fast and secure clamping of the linear gage head. The plain stem has the advantage of wider application and slight positional adjustment in the axial direction on final installation, although it does require a split-fixture clamping arrangement or adhesive fixing. However, take care so as not to exert excessive force on the stem.

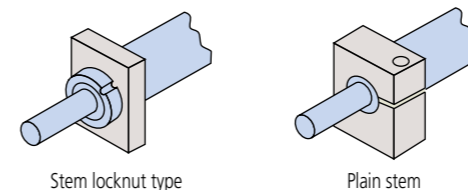

Measuring Force

This is the force exerted on a workpiece during measurement by the contact point of a linear gage head, at its stroke end, expressed in newtons.

Comparative Measurement

A measurement method where a workpiece dimension is found by measuring the difference in size between the workpiece and a master gage representing the nominal workpiece dimension.

Ingress Protection Code

IP54 protection code

Type	Level	Description
Protects the human body and protects against foreign objects	5: Dust protected	Protection against harmful dust
Protects against exposure to water	4: Splash-proof type	Water splashing against the enclosure from any direction shall have no harmful effect.

IP66 protection code

Type	Level	Description
Protection against contact with the human body and foreign objects	6: Dust tight	Protection from dust ingress Complete protection against contact
Protects against exposure to water	6: Water-resistant type	Water jets directed against the enclosure from any direction shall have no harmful effects.

Precautions in Mounting a Gage Head

- Insert the stem of the gage into the mounting clamp of a measuring unit or a stand and tighten the clamp screw.
- Notice that excessively tightening the stem can cause problems with spindle operation.
- Never use a mounting method in which the stem is clamped by direct contact with a screw.
- Never mount a linear gage by any part other than the stem.
- Mount the gage head so that it is in line with the intended direction of measurement. Mounting the head at an angle to this direction will cause an error in measurement.
- Exercise care so as not to exert a force on the gage through the cable.

Precautions in Mounting LGH Series

To fix the Laser Hologage, insert the stem into the dedicated stand or fixture.

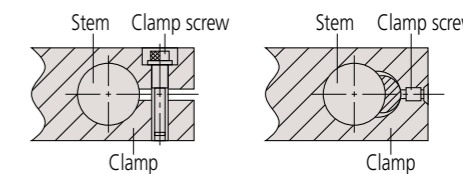

Recommended hole diameter on the fixing side: 15 mm +0.034/-0.014

- Machine the clamping hole so that its axis is parallel with the measuring direction. Mounting the gage at an angle will cause a measuring error.
- When fixing the Laser Hologage, do not clamp the stem too tightly. Over-tightening the stem may impair the sliding ability of the spindle.
- If measurement is performed while moving the LGH Series, mount it so that the cable will not be strained and no undue force will be exerted on the gage head.

Display Unit

Zero-setting

The display value can be set to 0 (zero) at any position of the spindle.

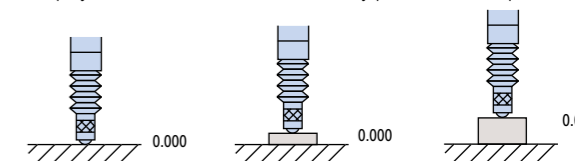

Presetting

Any numeric value can be set on the display unit for starting the count from this value.

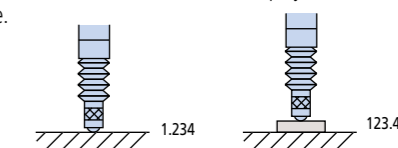

Direction changeover

The measuring direction of the gage spindle can be set to either plus (+) or minus (-) of count.

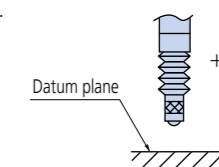

MAX, MIN, TIR Settings

The display unit can hold the maximum (MAX) and minimum (MIN) values, and the run out value (TIR) during measurement.

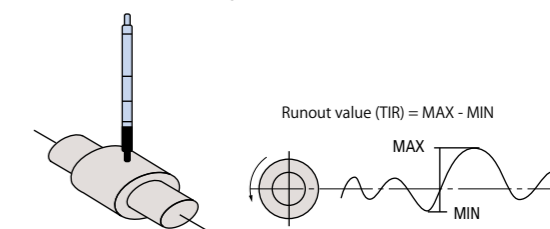

Linear Gages

Tolerance Setting

Tolerance limits can be set in various display units for automatically indicating if a measurement falls within those limits.

Open-collector Output

An external load, such as a relay or a logic circuit, can be driven from the collector output of an internal transistor which is itself controlled by a Tolerance Judgement result, etc.

Digimatic Code

A communication protocol for connecting the output of measuring tools with various Mitutoyo data processing units. This allows output connection to a Digimatic Mini Processor **DP-1VA LOGGER** for performing various statistical calculations and creating histograms, etc.

BCD Output

A system for outputting data in binary-coded decimal notation.

RS-232C Output

A serial communication interface in which data can be transmitted bi-directionally under the EIA Standards. For the transmission procedure, refer to the specifications of each measuring instrument.

RS Link Function Multi-point measurement can be performed by connecting multiple EH counters with RS Link cables.

RS Link for EH Counter

It is possible to connect a maximum of 10 counter units and handle up to 20 channels of multi-point measurement at a time. For this connection use a dedicated RS Link cable **No.02ADD950** (0.5m), **No.936937** (1m) or **No.965014** (2m). (The total length of RS Link cables permitted for the entire system is up to 10m.)

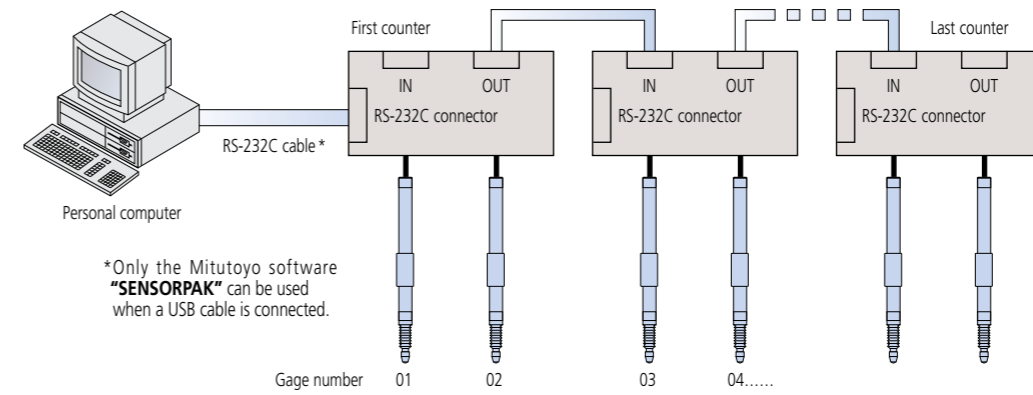

Linear Gages

Measurement Examples

Roll gap measurement



Chip parallelism measurement



FPD board multipoint measurement

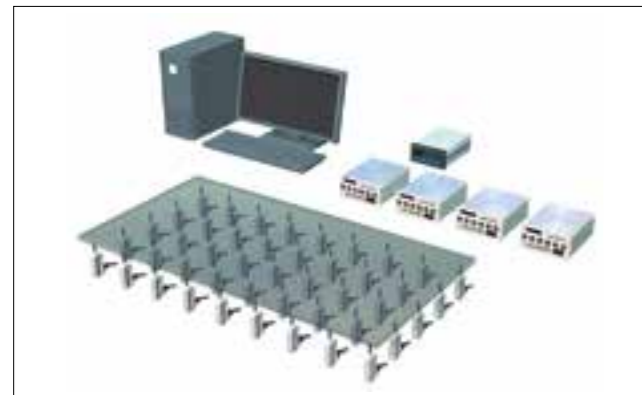

Cam-lift measurement



Brake disk multipoint measurement



Machine device tool length measurement



Workpiece discrimination

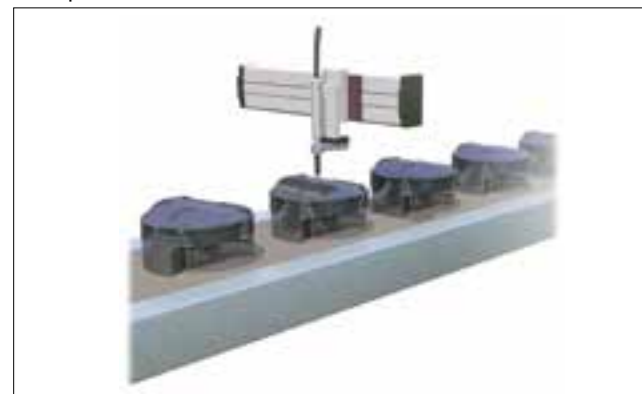

Inspection fixture

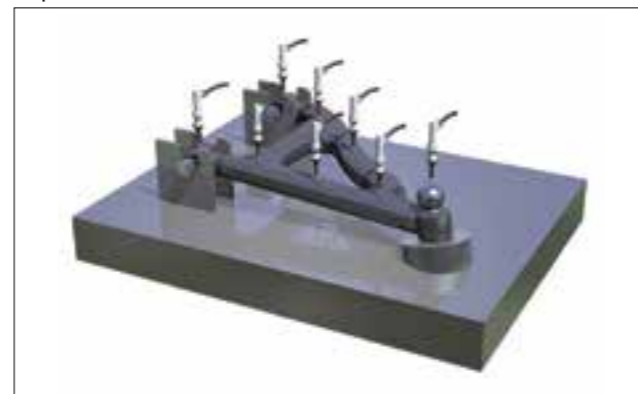

Electronic Micrometers

Probe

A sensor that converts movement of a contact point, on a stylus or plunger, into an electrical signal.

Lever probes

Lever probes are available in two types. The most common type uses a pivoted stylus so the contact point moves in a circular arc; this type is subject to cosine effect and, therefore, measurements may require linearity correction if the direction of measurement is much different to the direction of movement of the contact point. The less common type uses a parallel translation leaf-spring mechanism so contact point movement is linear; this type requires no correction.

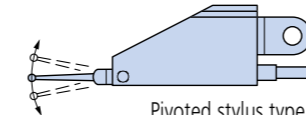

Pivoted stylus type
MLH-521 (measuring direction can be switched with the up/down lever)
MLH-522 (measuring direction is not switchable)

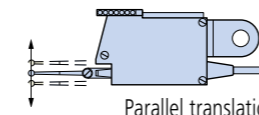

Parallel translation type
MLH-326 (measuring direction can be switched with the upper dial)

Pre-travel

The distance from first contact with a workpiece until the measurement indicator reads zero.

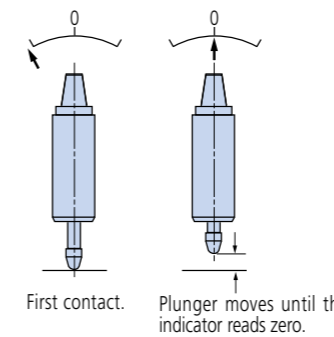

Measuring force

The force applied to the workpiece by the probe when the indicator registers zero. It is indicated in newtons (N).

Digimatic code

A communication protocol for connecting the output of measuring tools with various Mitutoyo data processing units. This allows output connection to a Digimatic Mini Processor **DP-1VA LOGGER** for performing various statistical calculations and creating histograms, etc.

Open collector output

A direct connection to the collector of a driving transistor.

Comparative measurement

A measurement method where a workpiece dimension is found by measuring the difference in size between the workpiece and a master gage that represents the nominal dimension. This method is usually applied when the measurement to be made is greater than the measuring range of the instrument.

Linearity

The ratio of proportionality between measuring system output and measured distance. If this is not constant within acceptable limits then correction is required.

0 (zero) point

A reference point on the master gage in a comparative measurement.

Sensitivity

The ratio of the electric micrometer output signal to the input signal to the amplifier. The sensitivity is normal if a value as expected from the given displacement is displayed.

Tolerance setting

Tolerance limits can be set on the electronic micrometer to provide an automatic judgment as to whether a measured value falls within the tolerance.

Lever-head angle

Before measurement, be sure to confirm that probe sensitivity adjustment has been completed. Changing the probe angle will cause variation in the measured values. Adjust the probe angle to obtain an optimum sensitivity before starting measurement. If it is difficult, adjust the sensitivity with the probe angle set to 0°, and after measurement, correct the measured values according to the actual probe angle (by multiplying the measured value by a correction factor).

Tips Correction using a correction factor may result in lower accuracy than when adjusting sensitivity with the actual probe angle.

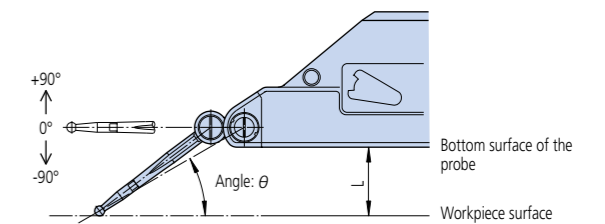

Angle: θ	Distance from the workpiece surface: L*	Correction factor
0°	—	1.00
10°	Approx. 3.1 mm	Approx. 0.98
20°	Approx. 8.8 mm	Approx. 0.94
30°	Approx. 13.9 mm	Approx. 0.87
40°	Approx. 18.3 mm	Approx. 0.77
50°	Approx. 21.6 mm	Approx. 0.64
60°	Approx. 23.8 mm	Approx. 0.50

* Value when using a carbide probe with spherical diameter of $\phi 2$ that is installed before shipment. When using a $\phi 1$ (or $\phi 3$) carbide probe, subtract (or add) 1/2 of the difference in spherical diameter.

Laser Scan Micrometers

Compatibility

Your Laser Scan Micrometer has been adjusted together with the ID Unit, which is supplied with the measuring unit. The ID Unit, which has the same code number and the same serial number as the measuring unit, must be installed in the display unit. This means that if the ID Unit is replaced the measuring unit can be connected to another corresponding display unit.

The workpiece and measuring conditions

Depending on whether the laser is visible or invisible, the workpiece shape, and the surface roughness, measurement errors may result. If this is the case, perform calibration with a master workpiece which has dimensions, shape, and surface roughness similar to the actual workpiece to be measured. If measurement values show a large degree of dispersion due to the measuring conditions, increase the number of scans for averaging to improve the measurement accuracy.

Electrical interference

To avoid operational errors, do not route the signal cable and relay cable of the Laser Scan Micrometer alongside a high-voltage line or other cable capable of inducing noise current in nearby conductors. Ground all appropriate units and cable shields.

Connection to a computer

If the Laser Scan Micrometer is to be connected to an external personal computer via the RS-232C interface, ensure that the cable connections conform to the specification.

Laser safety

Mitutoyo Laser Scan Micrometers use a low-power visible laser for measurement. The laser is a CLASS 2 EN/IEC60825-1 device. Warning and explanation labels, as shown right, are attached to the Laser Scan Micrometers as is appropriate.



Re-assembly after removal from the base

Observe the following limits when re-assembling the emission unit and reception unit to minimize measurement errors due to misalignment of the laser's optical axis with the reception unit.

Alignment within the horizontal plane

- a. Parallel deviation between reference lines C and D: X (in the transverse direction)

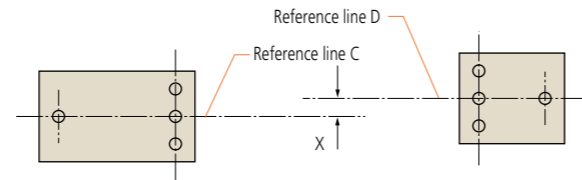

- b. Angle between reference lines C and D: θ_x (angle)

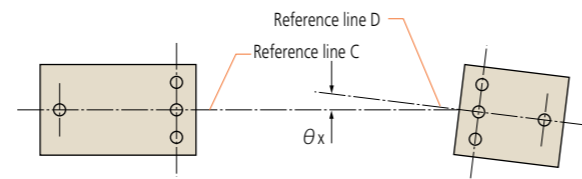

Alignment within the vertical plane

- c. Parallel deviation between reference planes A and B: Y (in height)

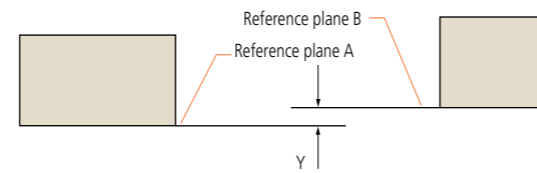

- d. Angle between reference planes A and B: θ_y (angle)

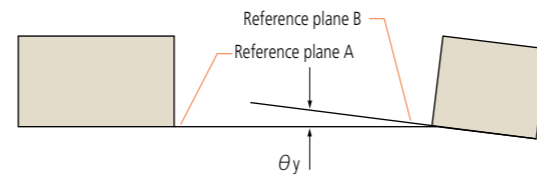

Allowable limits of optical axis misalignment

Model	Distance between Emission Unit and Reception Unit	X and Y	θ_x and θ_y
LSM-501S	68 mm (2.68") or less	within 0.5 mm (.02")	within 0.4' (7 mrad)
	100 mm (3.94") or less	within 0.5 mm (.02")	within 0.3' (5.2 mrad)
LSM-503S	130 mm (5.12") or less	within 1 mm (.04")	within 0.4' (7 mrad)
	350 mm (13.78") or less	within 1 mm (.04")	within 0.16' (2.8 mrad)
LSM-506S	273 mm (10.75") or less	within 1 mm (.04")	within 0.2' (3.5 mrad)
	700 mm (27.56") or less	within 1 mm (.04")	within 0.08' (1.4 mrad)
LSM-512S	321 mm (12.64") or less	within 1 mm (.04")	within 0.18' (3.6 mrad)
	700 mm (27.56") or less	within 1 mm (.04")	within 0.08' (1.4 mrad)
LSM-516S	800 mm (31.50") or less	within 1 mm (.04")	within 0.09' (1.6 mrad)

Measurement Examples

Measurement of outside diameter of rubber roll

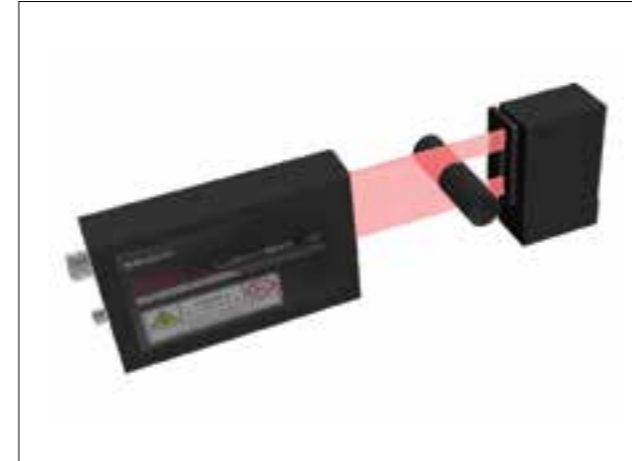

Simultaneous measurement of roller outside diameter and deflection



Measurement of uneven thickness of film or sheet (simultaneous measurement)

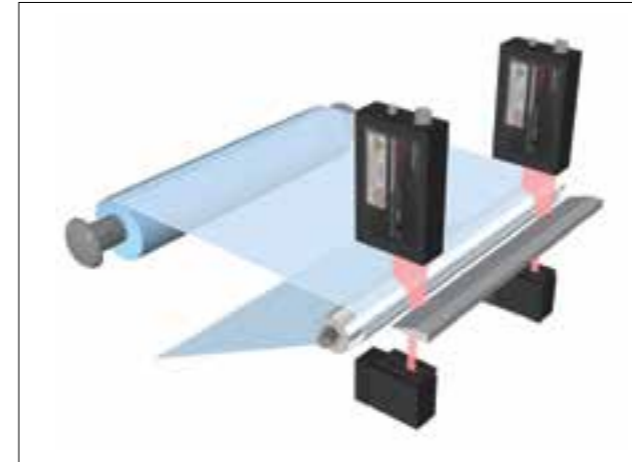

Measurement of gap between rollers



Measurement of film sheet thickness



Dual system for measuring a large outside diameter



Linear Scales

Glossary

Absolute system

A measurement mode in which every point measurement is made relative to a fixed origin point.

Incremental system

A measurement mode in which every point measurement is made relative to a certain stored reference point.

Origin offset

A function that enables the origin point of a coordinate system to be translated to another point offset from the fixed origin point. For this function to work, a system needs a permanently stored origin point.

Restoring the origin point

A function that stops each axis of a machine accurately in position specific to the machine while slowing it with the aid of integrated limit switches.

Sequence control

A type of control that sequentially performs control steps according to a prescribed order.

Numerical control

A way of controlling the movements of a machine by encoded commands created and implemented with the aid of a computer (CNC). A sequence of commands typically forms a 'part program' that instructs a machine to perform a complete operation on a workpiece.

Binary output

Refers to output of data in binary form (ones and zeros) that represent numbers as integer powers of 2.

RS-232C

An interface standard that uses an asynchronous method of serial transmission of data over an unbalanced transmission line for data exchange between transmitters located relatively close to each other. It is a means of communication mainly used for connecting a personal computer with peripherals.

Line driver output

This output features fast operating speeds of several tens to several hundreds of nanoseconds and a relatively long transmission distance of several hundreds of meters. A differential-voltmeter line driver (RS422A compatible) is used as an I/F to the NC controller in the linear scale system.

BCD

A notation of expressing the numerals 0 through 9 for each digit of a decimal number by means of four-bit binary sequence. Data transmission is one-way output by means of TTL or open collector.

RS-422

An interface standard that uses serial transmission of bits in differential form over a balanced transmission line. RS-422 is superior in its data transmission characteristics and in its capability of operating with only a single power supply of 5 VDC.

Accuracy

The accuracy specification of a scale is given in terms of the maximum error to be expected between the indicated and true positions at any point, within the range of that scale, at a temperature of 20°C. Since there is no international standard defined for scale units, each manufacturer has a specific way of specifying accuracy. The accuracy specifications given in our catalog have been determined using laser interferometry.

Narrow range accuracy

Scale gratings on a scale unit normally adopt 20µm pitch though it varies according to the kind of scale. The narrow range accuracy refers to the accuracy determined by measuring one pitch of each grating at the limit of resolution (1µm for example).

Specifying Linear Scale Accuracy

Positional Indication accuracy

The accuracy of a linear scale is determined by comparing the positional value indicated by the linear scale with the corresponding value from a laser length measuring machine at regular intervals using the accuracy inspection system as shown in the figure below. As the temperature of the inspection environment is 20 °C, the accuracy of the scale applies only in an environment at this temperature. Other inspection temperatures may be used to comply with internal standards.

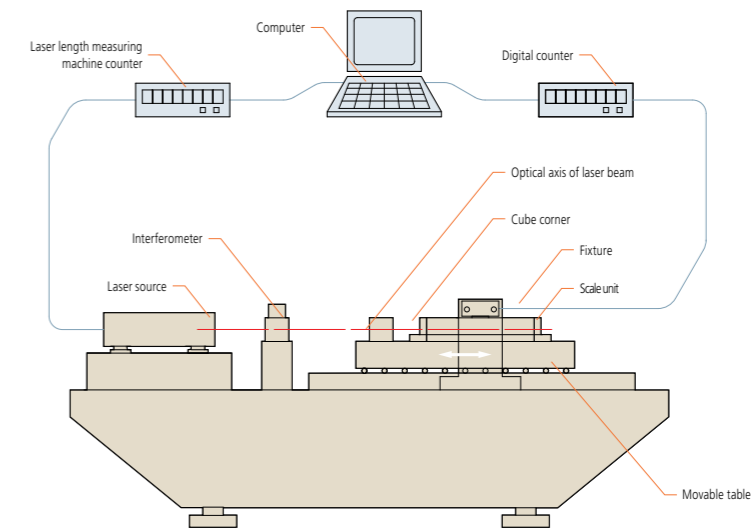

The accuracy of the scale at each point is defined in terms of an error value that is calculated using the following formula:

$$\text{Error} = \text{Value indicated by Laser length measuring machine} - \text{Corresponding value indicated by the linear scale}$$

A graph in which the error at each point in the effective positioning range is plotted is called an accuracy diagram. There are two methods used to specify the accuracy of a scale, unbalanced or balanced, described below.

(1) Unbalanced accuracy specification - maximum minus minimum error

This method simply specifies the maximum error minus the minimum error from the accuracy graph, as shown below. It is of the form: $E = (\alpha + \beta L)\mu\text{m}$. L is the effective range (mm), and α and β are factors specified for each model.

For example, if a particular type of scale has an accuracy specification of $(3 + \frac{3L}{1000})\mu\text{m}$ and an effective range of 1000 mm, E is 6 µm.

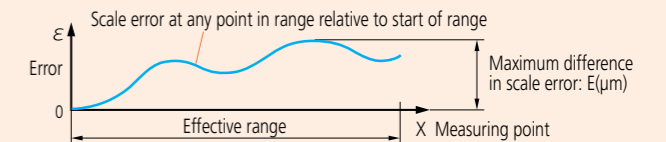

(2) Balanced accuracy specification - plus and minus about the mean error

This method specifies the maximum error relative to the mean error from the accuracy graph. It is of the form: $e = \pm \frac{E}{2} (\mu\text{m})$. This is mainly used in separate-type (retrofit) scale unit specifications.

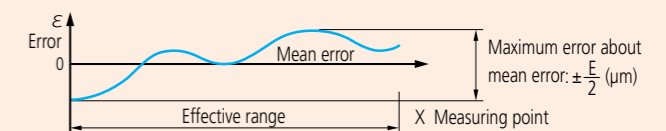

A linear scale detects displacement based on graduations of constant pitch. Two-phase sinusoidal signals with the same pitch as the graduations are obtained by detecting the graduations. Interpolating these signals in the electrical circuit makes it possible to read a value smaller than the graduations by generating pulse signals that correspond to the desired resolution. For example, if the graduation pitch is 20 µm, interpolated values can generate a resolution of 1 µm.

The accuracy of this processing is not error-free and is called interpolation accuracy. The linear scale's overall positional accuracy specification depends both on the pitch error of the graduations and interpolation accuracy.

Profile Projectors

Erect Image and Inverted Image

An image of an object projected onto a screen is erect if it is orientated the same way as the object on the stage. If the image is reversed top to bottom, left to right and by movement with respect to the object on the stage (as shown in the figure below) it is referred to as an inverted image (also known as a reversed image.)

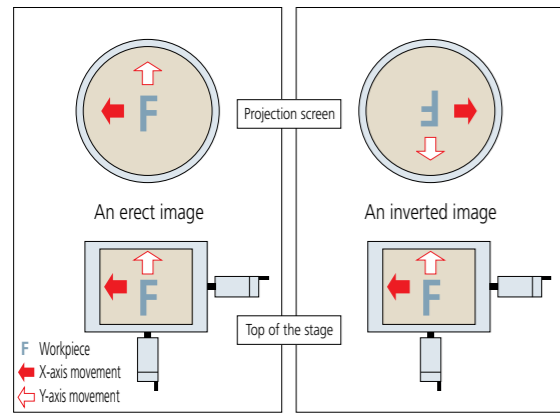

Working distance

Refers to the distance from the face of the projection lens to the surface of a workpiece in focus. It is represented by L in the diagram below.

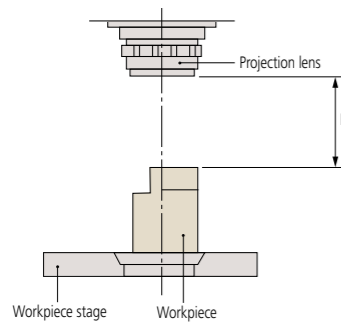

Magnification Accuracy

The magnification accuracy of a projector when using a certain lens is established by projecting an image of a reference object and comparing the size of the image of this object, as measured on the screen, with the expected size (calculated from the lens magnification, as marked) to produce a percentage magnification accuracy figure, as illustrated below. The reference object is often in the form of a small, graduated glass scale called a 'stage micrometer' or 'standard scale', and the projected image of this is measured with a larger glass scale known as a 'reading scale'.

(Note that magnification accuracy is not the same as measuring accuracy.)

$$\Delta M(\%) = \frac{L - \ell M}{\ell M} \times 100$$

$\Delta M(\%)$: Magnification accuracy expressed as a percentage of the nominal lens magnification
 L: Length of the projected image of the reference object measured on the screen
 ℓ : Length of the reference object
 M: Magnification of the projection lens

Type of Illumination

- Contour illumination: An illumination method to observe a workpiece by transmitted light and is used mainly for measuring the magnified contour image of a workpiece.

- Coaxial surface illumination: An illumination method whereby a workpiece is illuminated by light transmitted coaxially to the lens for the observation/measurement of the surface. (A half-mirror or a projection lens with a built-in half-mirror is needed.)
- Oblique surface illumination: A method of illumination by obliquely illuminating the workpiece surface. This method provides an image of enhanced contrast, allowing it to be observed three-dimensionally and clearly. However, note that an error is apt to occur in dimensional measurement with this method of illumination. (An oblique mirror is needed. Models in the PJ-H30 series are supplied with an oblique mirror.)

Parallax error

This is the displacement of an object against a fixed background caused by a change in the observer's position and a finite separation of the object and background planes. Can cause a reading error on a projector screen.

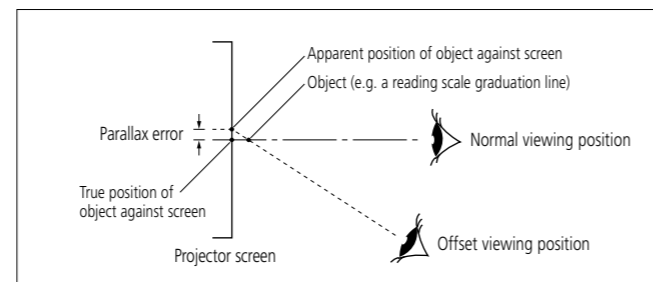

Field of view diameter

The maximum diameter of workpiece that can be projected using a particular lens.

$$\text{Field of view diameter (mm)} = \frac{\text{Screen diameter of profile projector}}{\text{Magnification of projection lens used}}$$

Example: If a 5X magnification lens is used for a projector with a screen of $\varnothing 500$ mm:
 Field of view diameter is given by $\frac{500 \text{ mm}}{5} = 100$ mm

Telecentric Optical System

An optical system based on the principle that the primary rays are aligned parallel to the optical axis by placing a lens stop on the focal point on the image side. Its functional feature is that the image will not vary in size even though the image blurs as the object is shifted along the optical axis.

For measuring projectors and measuring microscopes, an identical effect is obtained by placing a lamp filament at the focal point of a condenser lens instead of a lens stop so that the object is illuminated with parallel beams. (See the figure below.)

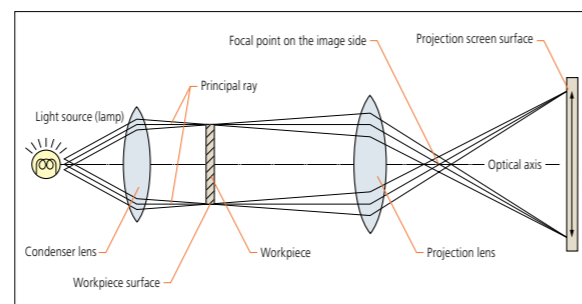

Microscopes

Numerical Aperture (NA)

The NA figure is important because it indicates the resolving power of an objective lens. The larger the NA value the finer the detail that can be seen. A lens with a larger NA also collects more light and will normally provide a brighter image with a narrower depth of focus than one with a smaller NA value.

$$NA = n \cdot \sin \theta$$

The formula above shows that NA depends on n , the refractive index of the medium that exists between the front of an objective and the specimen (for air, $n=1.0$), and angle θ , which is the half-angle of the maximum cone of light that can enter the lens.

Resolving Power (R)

The minimum detectable distance between two image points, representing the limit of resolution. Resolving power (R) is determined by numerical aperture (NA) and wavelength (λ) of the illumination.

$$R = \frac{\lambda}{2 \cdot NA} \text{ (}\mu\text{m)}$$

$\lambda = 0.55 \mu\text{m}$ is often used as the reference wavelength

Working Distance (W.D.)

The distance between the front end of a microscope objective and the surface of the workpiece at which the sharpest focusing is obtained.

Parfocal Distance

Distance between the surface of the specimen and the objective's seating surface when in focus.

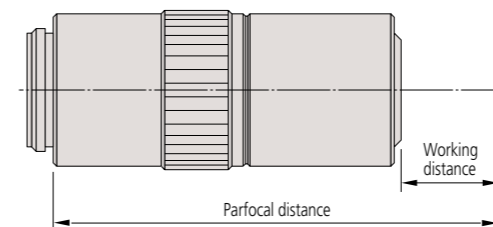

Focal Point

Light rays traveling parallel to the optical axis of a converging lens system and passing through that system will converge (or focus) to a point on the axis known as the rear focal point, or image focal point.

Infinity Optical System

An optical system in which the image is formed by an objective and a tube lens with an 'Infinity Space' between them, into which optical accessories can be inserted.

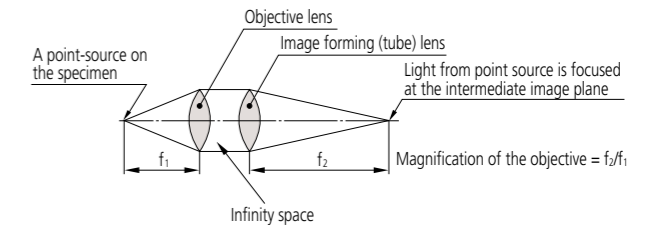

Finite-corrected Optical System

An optical system in which the image is formed only by an objective lens.

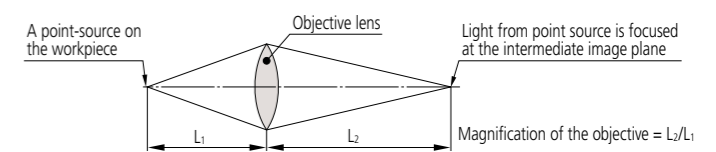

Focal Length (f)

unit: mm

The distance from the principal point to the focal point of a lens: if f_1 represents the focal length of an objective and f_2 represents the focal length of an image forming (tube) lens then magnification is determined by the ratio between the two. (In the case of the infinity-correction optical system.)

$$\text{Objective magnification} = \frac{\text{Focal length of the image-forming (tube) lens}}{\text{Focal length of the objective}}$$

Example: $1X = \frac{200}{200}$ Example: $10X = \frac{200}{20}$

Microscopes

Depth of Focus (DOF)

This is the distance (measured in the direction of the optical axis) between the two planes which define the limits of acceptable image sharpness when the microscope is focused on an object. As the numerical aperture (NA) increases, the depth of focus becomes shallower, as shown by the expression below:

$$DOF = \frac{\lambda}{2 \cdot (NA)^2} \quad \lambda = 0.55 \mu\text{m} \text{ is often used as the reference wavelength}$$

Example: For an **M Plan Apo 100X** lens (NA = 0.7)
 The depth of focus of this objective is
 $\frac{0.55 \mu\text{m}}{2 \times 0.7^2} = 0.6 \mu\text{m}$

Bright-field and Dark-field Illumination

In bright-field illumination a full cone of light is focused by the objective on the specimen surface. This is the normal mode of viewing with an optical microscope. With dark-field illumination, the inner area of the light cone is blocked so that the surface is only illuminated by light from an oblique angle. Dark-field illumination is good for detecting surface scratches and contamination.

Apochromat and Achromat Objective

An apochromat objective is a lens corrected for chromatic aberration (color blur) in three colors (red, green, blue).
 An achromat objective is a lens corrected for chromatic aberration in two colors (red, blue).

Magnification

The ratio of the size of a magnified object image created by an optical system to that of the object. Magnification commonly refers to lateral magnification although it can mean lateral, vertical, or angular magnification.

Principal Ray

A ray considered to be emitted from an object point off the optical axis and passing through the center of an aperture diaphragm in a lens system.

Aperture Diaphragm

An adjustable circular aperture which controls the amount of light passing through a lens system. It is also referred to as an aperture stop and its size affects image brightness and depth of focus.

Field Stop

An aperture which controls the field of view in an optical instrument.

Telecentric System

An optical system where the light rays are parallel to the optical axis in object and/or image space. This means that magnification is nearly constant over a range of working distances, therefore almost eliminating perspective error.

Erect Image

An image in which the orientations of left, right, top, bottom and moving directions are the same as those of a workpiece on the workstage.

Field number (FN), real field of view, and monitor display magnification

The observation range of the sample surface is determined by the diameter of the eyepiece's field stop. The value of this diameter in millimeters is called the field number (FN). In contrast, the real field of view is the range on the workpiece surface when actually magnified and observed with the objective lens.

The real field of view can be calculated with the following formula:

(1) The range of the workpiece that can be observed with the microscope (diameter)

$$\text{Real field of view} = \frac{\text{FN of eyepiece}}{\text{Objective lens magnification}}$$

Example: The real field of view of a 10X lens is $2.4 = \frac{24}{10}$

(2) Monitor observation range

$$\text{Monitor observation range} = \frac{\text{The size of the camera image sensor (diagonal length)}}{\text{Objective lens magnification}}$$

Size of image sensor

Format	Diagonal length	Length	Height
1/3 in	6.0	4.8	3.6
1/2 in	8.0	6.4	4.8
2/3 in	11.0	8.8	6.6

(3) Monitor display magnification

$$\text{Monitor display magnification} = \frac{\text{Display diagonal length on the monitor}}{\text{Diagonal length of camera image sensor}} \times \text{Objective lens magnification}$$

Vision Measuring Machines

Vision Measurement

Vision measuring machines mainly provide the following processing capabilities.

Edge detection

Detecting/measuring edges in the XY plane

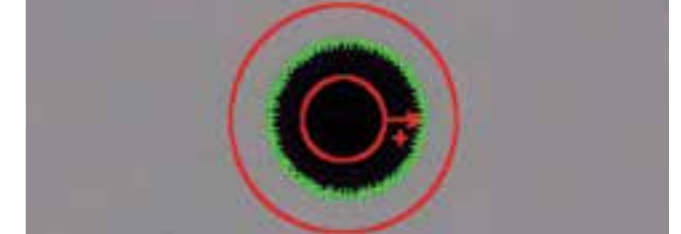
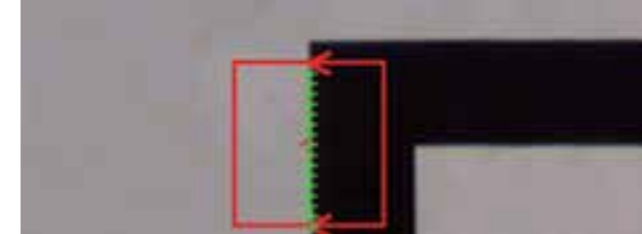

Auto focusing

Focusing and Z measurement

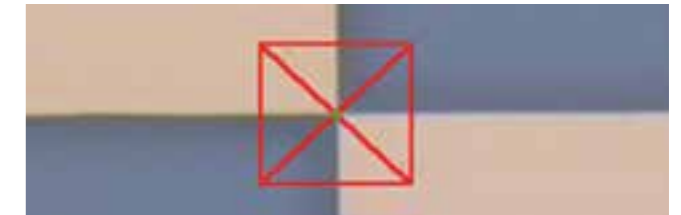

Pattern recognition

Alignment, positioning, and checking a feature

Image Storage

An image is comprised of a regular array of pixels. This is just like a picture on fine plotting paper with each square solid-filled differently.

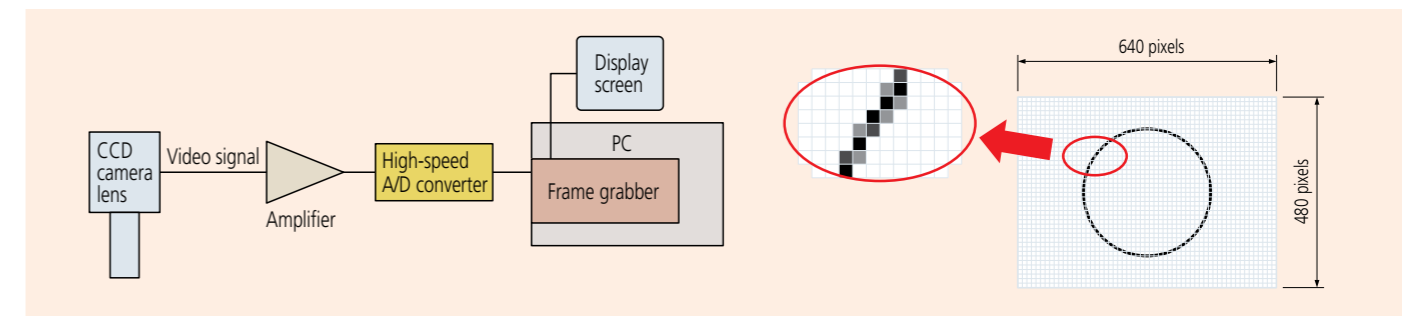

Gray Scale

A PC stores an image after internally converting it to numeric values. A numeric value is assigned to each pixel of an image. Image quality varies depending on how many levels of gray scale are defined by the numeric values. The PC provides two types of gray scale: two-level and multi-level. The pixels in an image are usually displayed as 256-level gray scale.

2-level gray scale

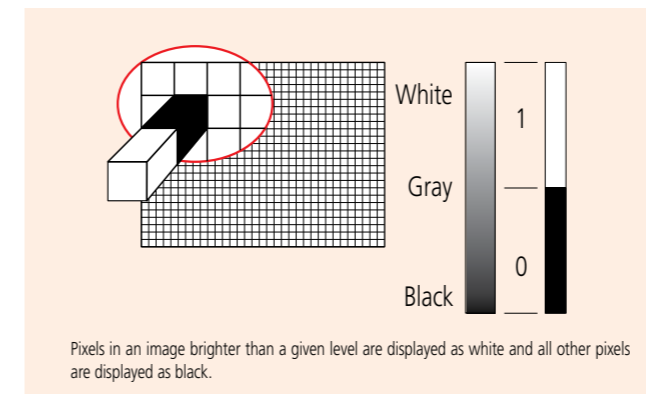

Multi-level gray scale

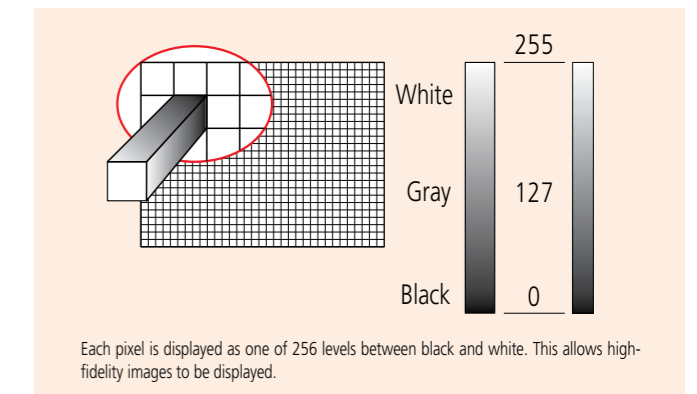

Vision Measuring Machines

Dimensional Measurement

An image consists of pixels. If the number of pixels in a section to be measured is counted and is multiplied by the size of a pixel, then the section can be converted to a numeric value in length. For example, assume that the total number of pixels in the lateral size of a square workpiece is 300 pixels as shown in the figure below. If a pixel size is $10\ \mu\text{m}$ under imaging magnification, the total length of the workpiece is given by $10\ \mu\text{m} \times 300\ \text{pixels} = 3000\ \mu\text{m} = 3\ \text{mm}$.

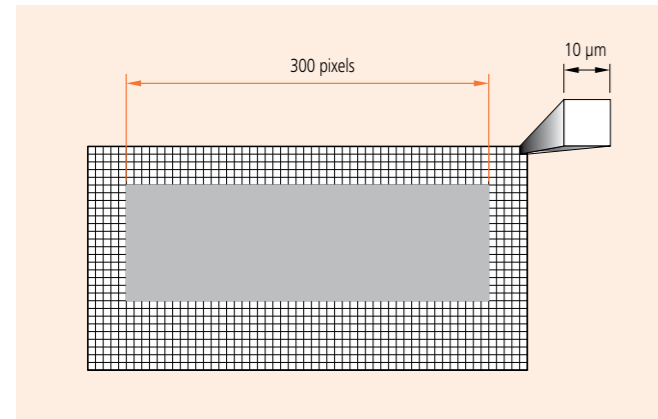

Edge Detection

How to actually detect a workpiece edge in an image is described using the following monochrome picture as an example. Edge detection is performed within a given domain. A symbol which visually defines this domain is referred to as a tool. Multiple tools are provided to suit various workpiece geometries or measurement data.

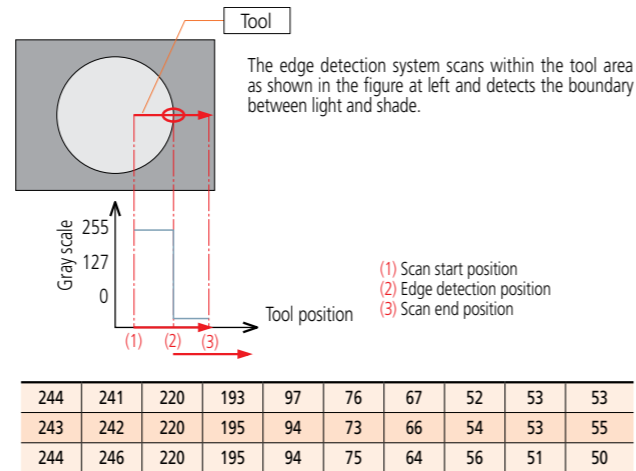

High-resolution Measurement

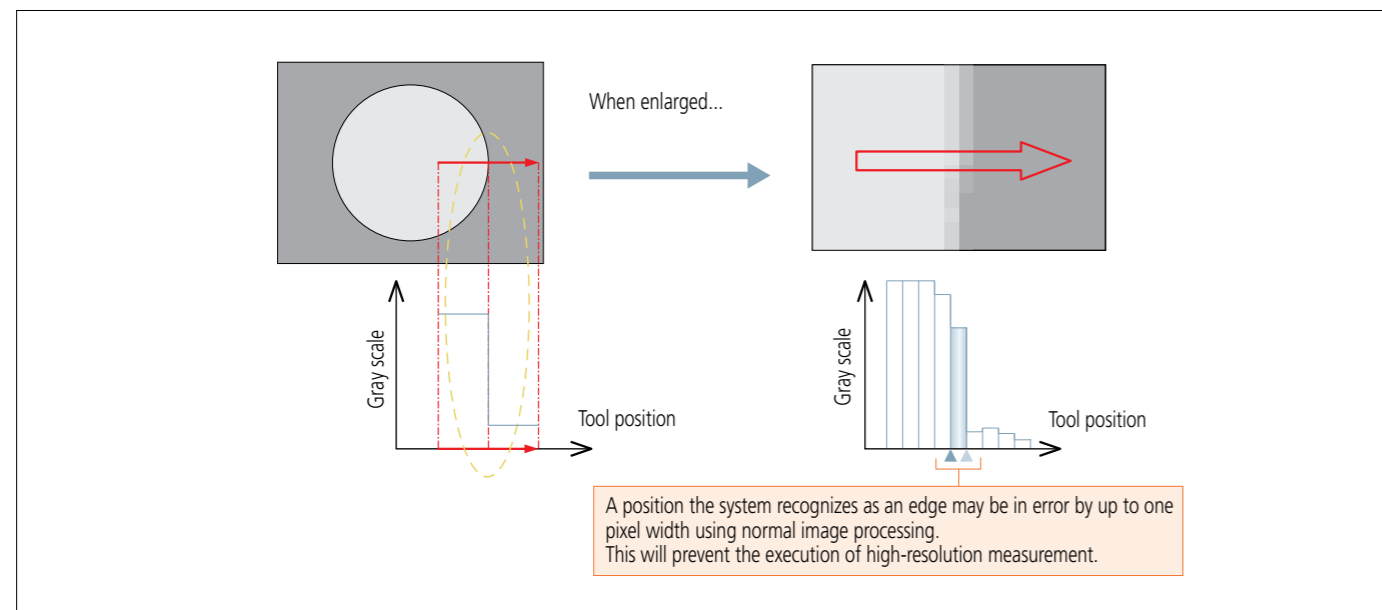

To increase the accuracy in edge detection, sub-pixel image processing is used. An edge is detected by determining interpolation curve from adjacent pixel data as shown below. As a result, it allows measurement with a resolution higher than 1 pixel.

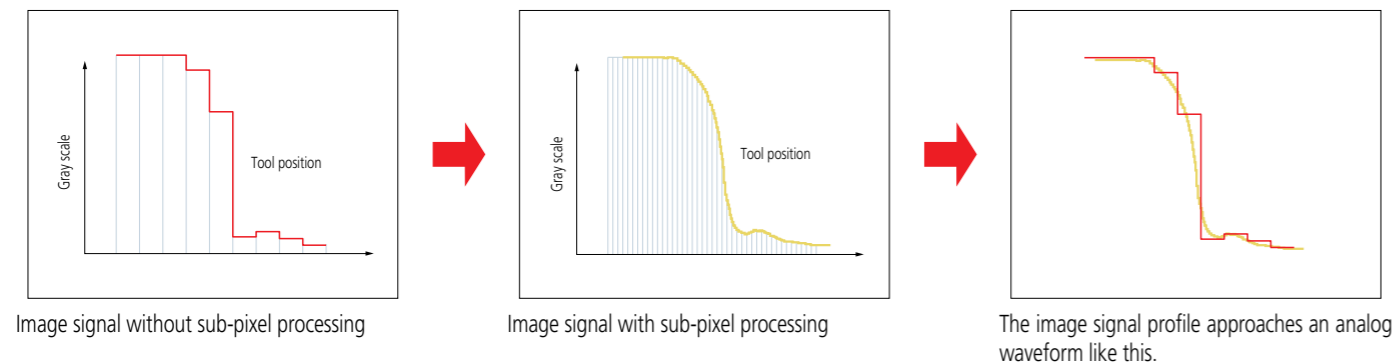

Measurement along Multiple Portions of an Image

Large features that cannot be contained on one screen have to be measured by precisely controlling the position of the sensor and stage so as to locate each reference point within individual images. By this means the system can measure even a large circle, as shown below, by detecting the edge while moving the stage across various parts of the periphery.

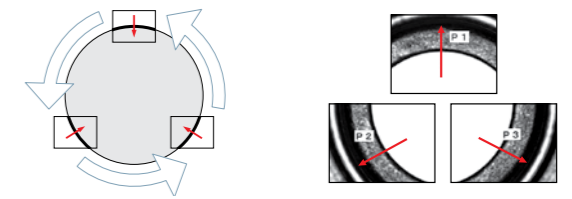

Composite Coordinates of a Point

Since measurement is performed while individual measured positions are stored, the system can measure dimensions that cannot be included in one screen, without problems.

Machine coordinate system

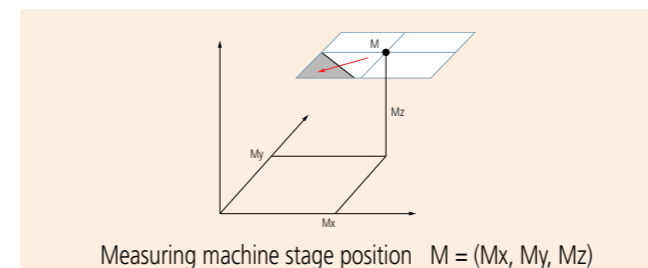

Actual coordinates are given by $X = (M_x + V_x)$, $Y = (M_y + V_y)$, and $Z = M_z$, respectively.

Vision coordinate system

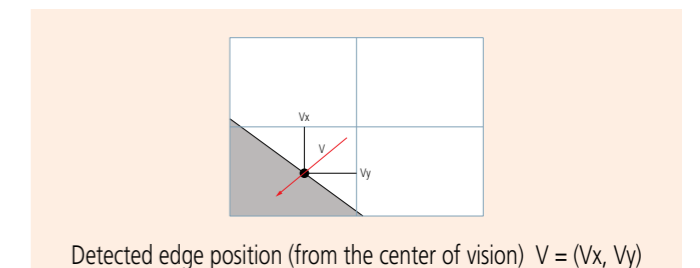

Principle of Auto Focusing

The system can perform XY-plane measurement, but cannot perform height measurement using only the camera image. The system is commonly provided with the Auto Focus (AF) mechanism for height measurement. The following explains the AF mechanism that uses a common image, although some systems may use an AF laser.

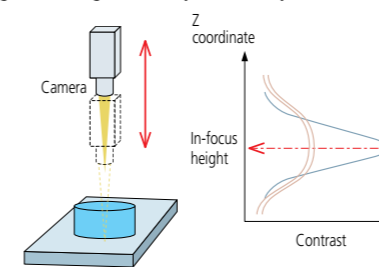

The AF system analyzes an image while moving the Camera up and down in the Z axis. In the analysis of image contrast, an image in sharp focus will show a peak contrast and one out of focus will show a low contrast. Therefore, the height at which the image contrast peaks is the just-in-focus height.

Variation in Contrast Depending on the Focus Condition

Edge contrast is low due to out-of-focus edges.

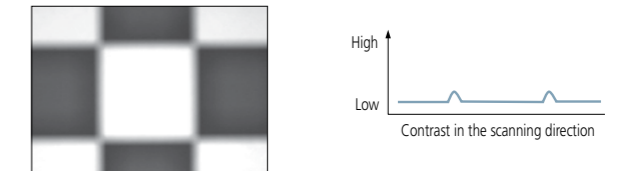

Edge contrast is high due to sharp, in-focus edges.

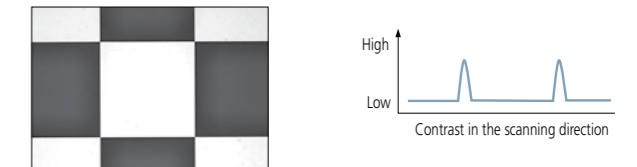

Overview of ISO 10360-7

ISO10360-7 (Geometrical product specifications (GPS) -- Acceptance and reverification tests for coordinate measuring machines (CMM) -- Part 7: CMMs equipped with imaging probing systems) was published on June 1, 2011. Some inspecting items are listed in ISO10360-7. The following summarizes the test method for determining length measurement error (E) and probing error (PF_{2D}).

Length measurement error, E

Five test lengths in seven different directions within the measuring volume, each length measured three times, for a total of 105 measurements. Four directions are the space diagonals; remaining three positions are user specified; default locations are parallel to VMM axes. When CTE (coefficient of thermal expansion) of the test-length artifact is $< 2 \times 10^{-6}/\text{K}$, additional measurement of artifact with normal CTE (8 to $13 \times 10^{-6}/\text{K}$) is performed.

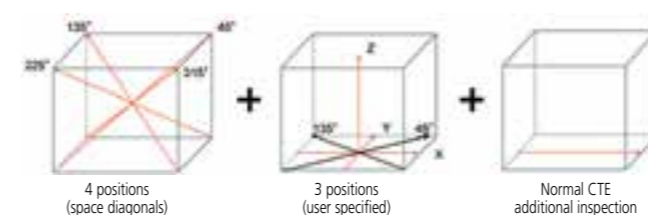

Probing error, P_{F2D}

Measure 25 points distributed evenly around the test circle (14.4° pitch). Each of the 25 points shall be measured by using the specified 25 areas of the field of view. Calculate probing error as the range of the 25 radial distances ($R_{\text{max}} - R_{\text{min}}$) from the center of the least-square circle.

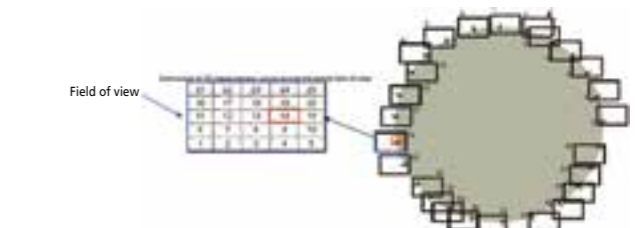

Surftest (Surface Roughness Testers)

- ISO 4287: 1997 Geometrical Product Specifications (GPS) –Surface Texture: Profile method– Terms, definitions, and surface texture parameters
- ISO 4288: 1996 Geometrical Product Specifications (GPS) –Surface Texture: Profile method– Rules and procedures for the assessment of surface texture
- ISO 3274: 1996 Geometrical Product Specifications (GPS) –Surface Texture: Profile method– Nominal characteristics of contact (stylus) instruments
- ISO 11562: 1996 Geometrical Product Specifications (GPS) –Surface Texture: Profile method– Metrological characteristics of phase-correct filters

Elements of Contact Type Surface Roughness Measuring Instruments

ISO 3274: 1996 (JIS B 0651: 2001)

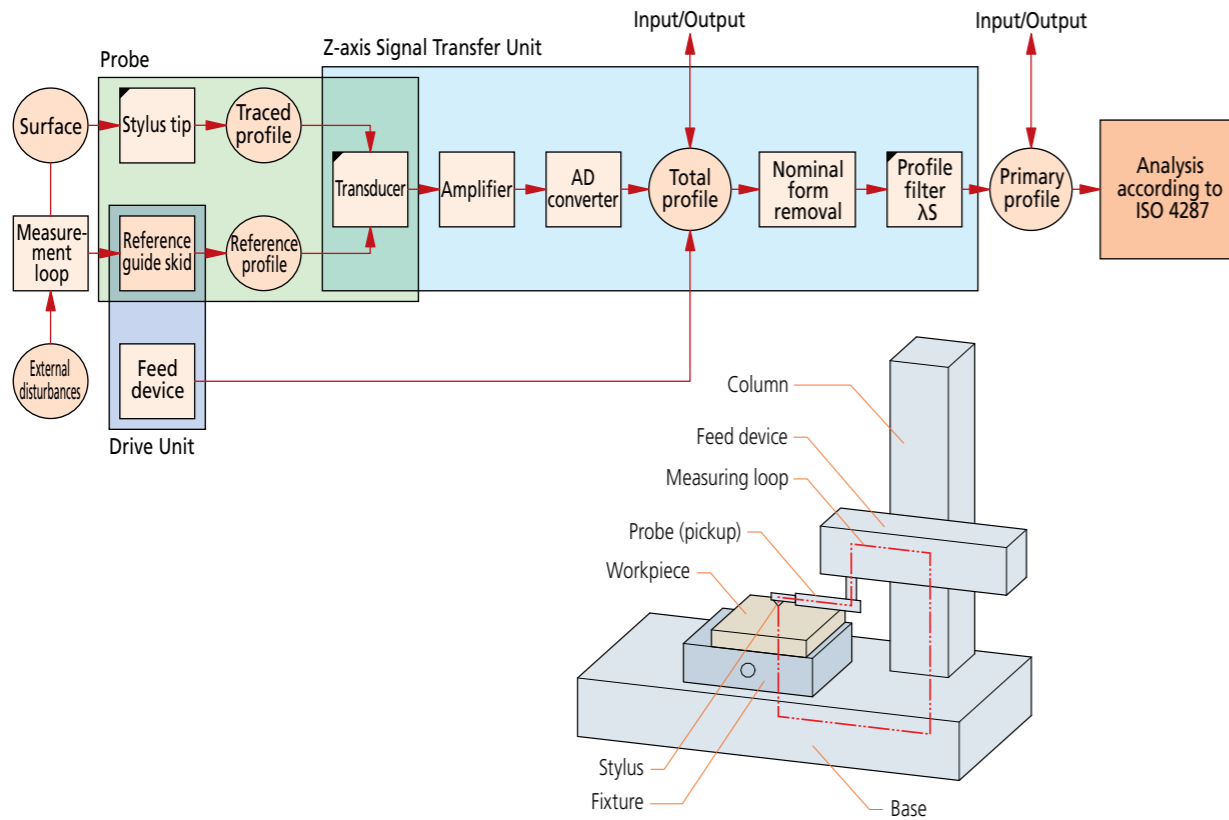

Stylus Shape

A typical shape for a stylus end is conical with a spherical tip.
 Tip radius: $r_{tip} = 2 \mu\text{m}, 5 \mu\text{m}$ or $10 \mu\text{m}$
 Cone angle: $60^\circ, 90^\circ$
 In typical surface roughness testers, the taper angle of the stylus end is 60° unless otherwise specified.

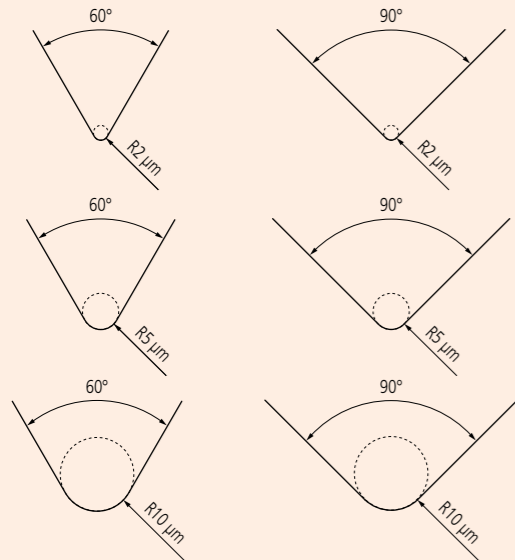

Static Measuring Force (JISB0651)

Nominal radius of curvature of stylus tip: μm	Static measuring force at the mean position of stylus: mN	Tolerance on static measuring force variations: mN/ μm
2	0.75	0.035
5	0.75 (4.0) ^{Note 1}	0.2
10		

Note 1: The maximum value of static measuring force at the average position of a stylus is to be 4.0 mN for a probe with a special structure including a replaceable stylus.

Relationship between Cutoff Value and Stylus Tip Radius

The following table lists the relationship between the roughness profile cutoff value λ_c , stylus tip radius r_{tip} , and cutoff ratio λ_c/r_{tip} .

λ_c mm	λ_s μm	λ_c / λ_s	Maximum r_{tip} μm	Maximum sampling length μm
0.08	2.5	30	2	0.5
0.25	2.5	100	2	0.5
0.8	2.5	300	2 ^{Note 1}	0.5
2.5	8	300	5 ^{Note 2}	1.5
8	25	300	10 ^{Note 2}	5

Note 1: For a surface with $R_a > 0.5 \mu\text{m}$ or $R_z > 3 \mu\text{m}$, a significant error will not usually occur in a measurement even if $r_{tip} = 5 \mu\text{m}$.
 Note 2: If a cutoff value λ_s is $2.5 \mu\text{m}$ or $8 \mu\text{m}$, attenuation of the signal due to the mechanical filtering effect of a stylus with the recommended tip radius appears outside the roughness profile pass band. Therefore, a small error in stylus tip radius or shape does not affect parameter values calculated from measurements.
 If a specific cutoff ratio is required, the ratio must be defined.

Metrological Characterization of Phase Correct Filters

ISO 11562: 1996 (JIS B 0632: 2001)

A profile filter is a phase-correct filter without phase delay (cause of profile distortion dependent on wavelength). The weight function of a phase-correct filter shows a normal (Gaussian) distribution in which the amplitude transmission is 50 % at the cutoff wavelength.

Surface Profiles

ISO 4287:1997 (JIS B 0601: 2013)

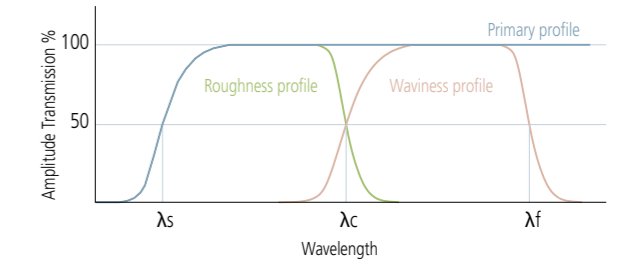

Data Processing Flow

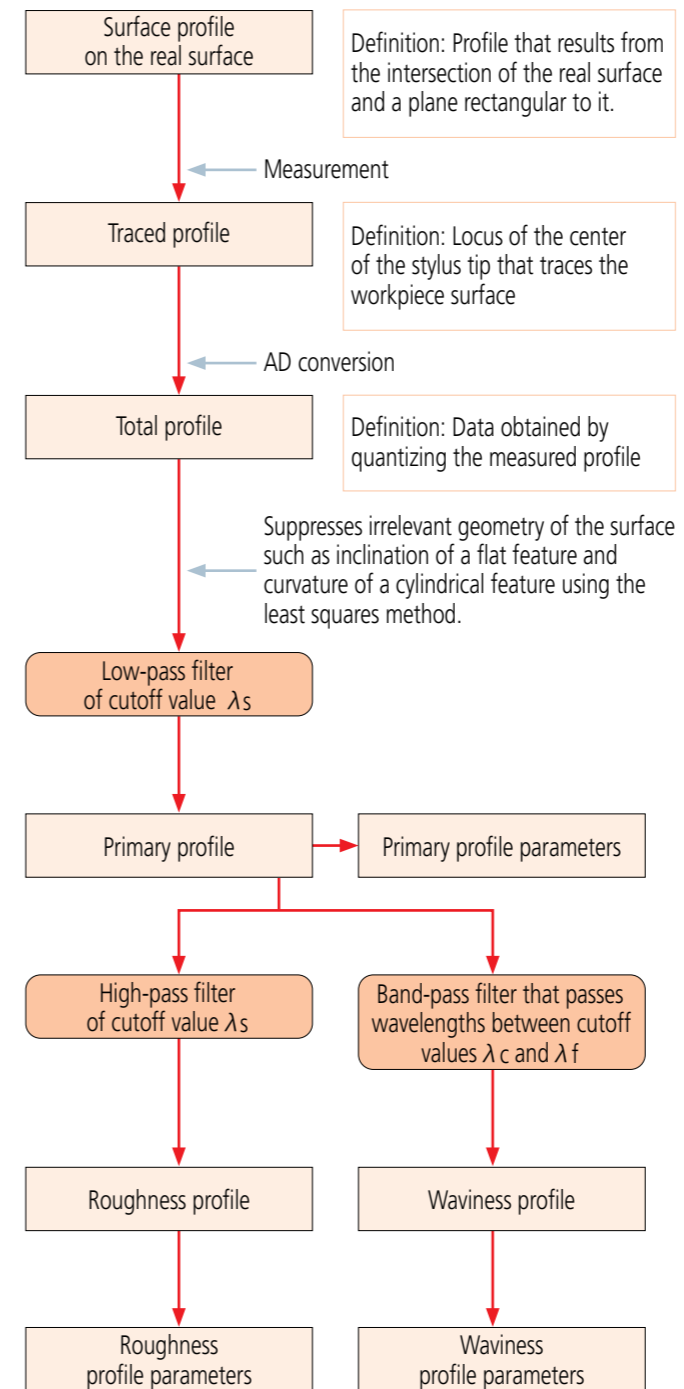

Primary Profile

Profile obtained from the measured profile by applying a low-pass filter with cutoff value λ_s .

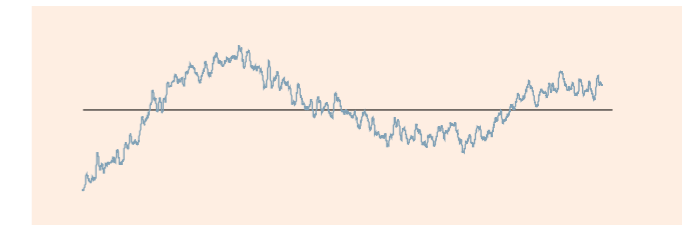

Roughness Profile

Profile obtained from the primary profile by suppressing the longer wavelength components using a high-pass filter of cutoff value λ_c .

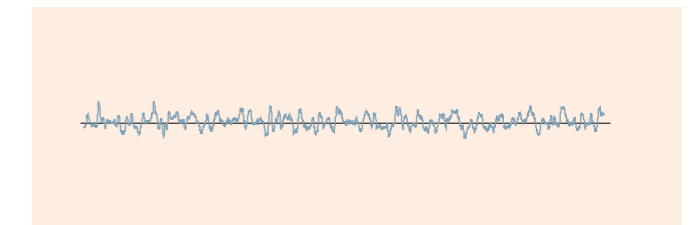

Waviness Profile

Profile obtained by applying a band-pass filter to the primary profile to remove the longer wavelengths above λ_f and the shorter wavelengths below λ_c .

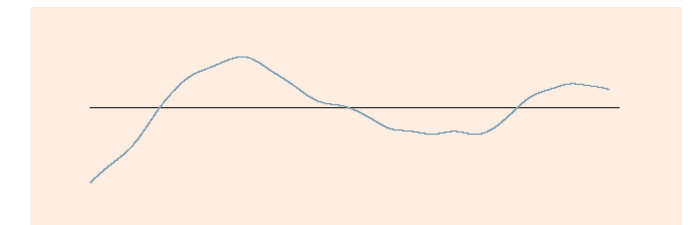

Surftest (Surface Roughness Testers)

Definition of Parameters

ISO 4287: 1997, Amd.1: 2009 (JIS B 0261: 2013)

Amplitude Parameters (peak and valley)

- Maximum peak height of the primary profile Pp**
- Maximum peak height of the roughness profile Rp**
- Maximum peak height of the waviness profile Wp**
- Largest profile peak height Zp within a sampling length

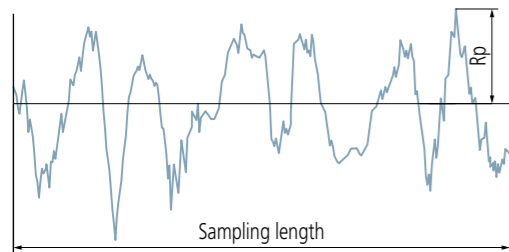

- Maximum valley depth of the primary profile Pv**
- Maximum valley depth of the roughness profile Rv**
- Maximum valley depth of the waviness profile Wv**
- Largest profile valley depth Zv within a sampling length

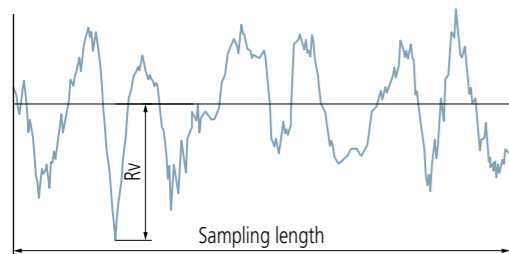

- Maximum height of the primary profile Pz**
- Maximum height of the roughness profile Rz**
- Maximum height of the waviness profile Wz**
- Sum of height of the largest profile peak height Zp and the largest profile valley depth Zv within a sampling length

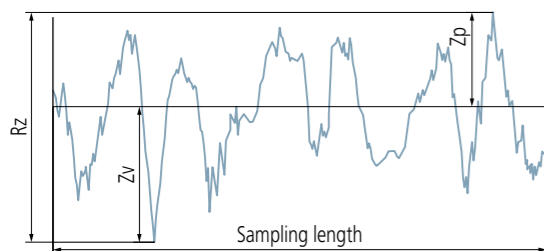

! In Old JIS and ISO 4287-1: 1984, Rz was used to indicate the "ten point height of irregularities". Care must be taken because differences between results obtained according to the existing and old standards are not always negligibly small. (Be sure to check whether the drawing instructions conform to existing or old standards.)

- Mean height of the primary profile elements Pc**
- Mean height of the roughness profile elements Rc**
- Mean height of the waviness profile elements Wc**
- Mean value of the profile element heights Zt within a sampling length

$$Pc, Rc, Wc = \frac{1}{m} \sum_{i=1}^m Zt_i$$

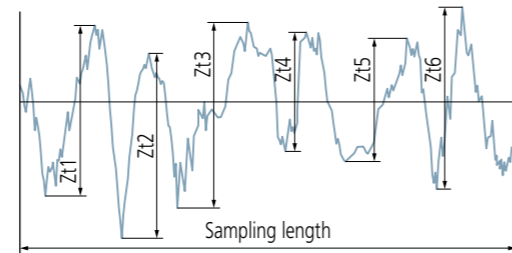

- Total height of the primary profile Pt**
- Total height of the roughness profile Rt**
- Total height of the waviness profile Wt**
- Sum of the height of the largest profile peak height Zp and the largest profile valley depth Zv within the evaluation length

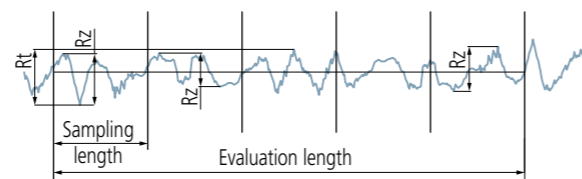

Amplitude Parameters (average of ordinates)

- Arithmetical mean deviation of the primary profile Pa**
- Arithmetical mean deviation of the roughness profile Ra**
- Arithmetical mean deviation of the waviness profile Wa**
- Arithmetic mean of the absolute ordinate values $Z(x)$ within a sampling length

$$Pa, Ra, Wa = \frac{1}{l} \int_0^l |Z(x)| dx$$

with l as lp , lr , or lw according to the case.

- Root mean square deviation of the primary profile Pq**
- Root mean square deviation of the roughness profile Rq**
- Root mean square deviation of the waviness profile Wq**
- Root mean square value of the ordinate values $Z(x)$ within a sampling length

$$Pq, Rq, Wq = \sqrt{\frac{1}{l} \int_0^l Z^2(x) dx}$$

with l as lp , lr , or lw according to the case.

- Skewness of the primary profile Psk**
- Skewness of the roughness profile Rsk**
- Skewness of the waviness profile Wsk**
- Quotient of the mean cube value of the ordinate values $Z(x)$ and the cube of Pq , Rq , or Wq respectively, within a sampling length

$$Rsk = \frac{1}{Rq^3} \left[\frac{1}{l} \int_0^l Z^3(x) dx \right]$$

The above equation defines Rsk . Psk and Wsk are defined in a similar manner. Psk , Rsk , and Wsk are measures of the asymmetry of the probability density function of the ordinate values.

- Kurtosis of the primary profile Pku**
- Kurtosis of the roughness profile Rku**
- Kurtosis of the waviness profile Wku**
- Quotient of the mean quartic value of the ordinate values $Z(x)$ and the fourth power of Pq , Rq , or Wq respectively, within a sampling length

$$Rku = \frac{1}{Rq^4} \left[\frac{1}{l} \int_0^l Z^4(x) dx \right]$$

The above equation defines Rku . Pku and Wku are defined in a similar manner. Pku , Rku , and Wku are measures of the sharpness of the probability density function of the ordinate values.

Spacing Parameters

- Mean width of the primary profile elements PSm**
- Mean width of the roughness profile elements RSm**
- Mean width of the waviness profile elements WSm**
- Mean value of the profile element widths Xs within a sampling length

$$PSm, RSm, WSm = \frac{1}{m} \sum_{i=1}^m Xs_i$$

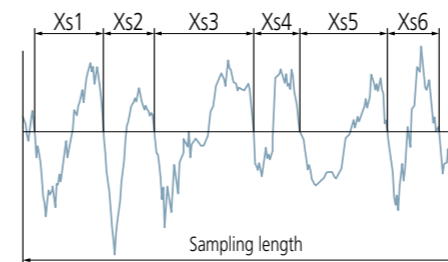

- Peak count number based on the primary profile elements PPc**
- Peak count number based on the roughness profile elements RPC**
- Peak count number based on the waviness profile elements WPC**

$$RPC = \frac{1}{RSm}$$



Hybrid Parameters

- Root mean square slope of the primary profile PAq**
- Root mean square slope of the roughness profile RAq**
- Root mean square slope of the waviness profile WAq**
- Root mean square value of the ordinate slope dZ/dX within a sampling length

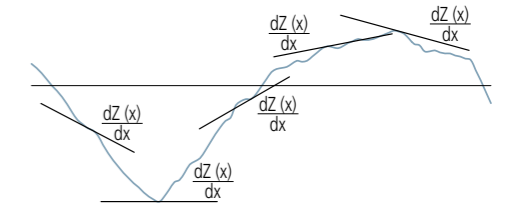

JIS Specific Parameters

- Ten-point height of irregularities, Rz_{JIS}**
- Sum of the absolute mean height of the five highest profile peaks and the absolute mean depth of the five deepest profile valleys, measured from the mean line within the sampling length of a roughness profile. This profile is obtained from the primary profile using a phase-correct band-pass filter with cutoff values of lc and ls .

$$Rz_{JIS} = \frac{(Zp_1 + Zp_2 + Zp_3 + Zp_4 + Zp_5) + (Zv_1 + Zv_2 + Zv_3 + Zv_4 + Zv_5)}{5}$$

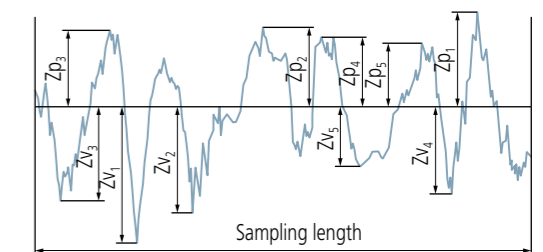

Symbol	Used profile
Rz_{JIS82}	Surface profile as measured
Rz_{JIS94}	Roughness profile derived from the primary profile using a phase-correct high-pass filter

Arithmetic mean deviation of the profile Ra_{75}

Arithmetic mean of the absolute values of the profile deviations from the mean line within the sampling length of the roughness profile (75%). This profile is obtained from a measurement profile using an analog high-pass filter with an attenuation factor of 12db/octave and a cutoff value of λc .

$$Ra_{75} = \frac{1}{l} \int_0^l |Z(x)| dx$$

Surftest (Surface Roughness Testers)

Curves, Probability Density Function, and Related Parameters

Material ratio curve of the profile (Abbott-Firestone curve)
Curve representing the material ratio of the profile as a function of section level c

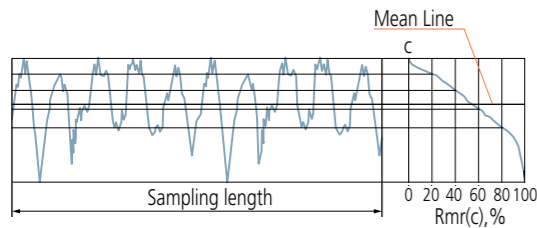

Probability density function (profile height amplitude distribution curve)

Sample probability density function of the ordinate $Z(x)$ within the evaluation length

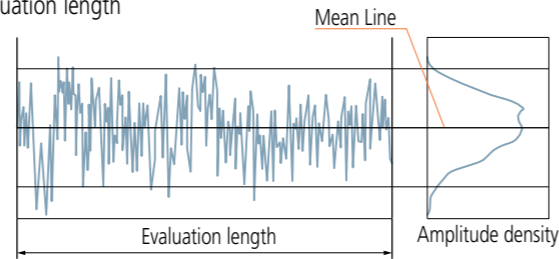

Roughness sampling length for non-periodic profiles ISO 4288: 1996 (JIS B 0633: 2001)

Table 1: Sampling lengths for aperiodic profile roughness parameters (R_a , R_q , R_{sk} , R_{ku} , $R_{\Delta q}$), material ratio curve, probability density function, and related parameters

R_a μm	Sampling length l_r mm	Evaluation length l_n mm
$0.006 < R_a \leq 0.02$	0.08	0.4
$0.02 < R_a \leq 0.1$	0.25	1.25
$0.1 < R_a \leq 2$	0.8	4
$2 < R_a \leq 10$	2.5	12.5
$10 < R_a \leq 80$	8	40

Table 2: Sampling lengths for aperiodic profile roughness parameters (R_z , R_v , R_p , R_c , R_t)

R_z , $R_{z1\text{max}}$ μm	Sampling length l_r mm	Evaluation length l_n mm
$0.025 < R_z, R_{z1\text{max}} \leq 0.1$	0.08	0.4
$0.1 < R_z, R_{z1\text{max}} \leq 0.5$	0.25	1.25
$0.5 < R_z, R_{z1\text{max}} \leq 10$	0.8	4
$10 < R_z, R_{z1\text{max}} \leq 50$	2.5	12.5
$50 < R_z, R_{z1\text{max}} \leq 200$	8	40

1) R_z is used for measurement of R_z , R_v , R_p , R_c , and R_t .
2) $R_{z1\text{max}}$ only used for measurement of $R_{z1\text{max}}$, $R_{v1\text{max}}$, $R_{p1\text{max}}$, and $R_{c1\text{max}}$.

Table 3: Sampling lengths for measurement of periodic roughness profile roughness parameters and periodic or aperiodic profile parameter R_{sm}

R_{sm} mm	Sampling length l_r mm	Evaluation length l_n mm
$0.013 < R_{sm} \leq 0.04$	0.08	0.4
$0.04 < R_{sm} \leq 0.13$	0.25	1.25
$0.13 < R_{sm} \leq 0.4$	0.8	4
$0.4 < R_{sm} \leq 1.3$	2.5	12.5
$1.3 < R_{sm} \leq 4$	8	40

Material ratio of the primary profile $P_{mr}(c)$

Material ratio of the roughness profile $R_{mr}(c)$

Material ratio of the waviness profile $W_{mr}(c)$

Ratio of the material length of the profile elements $MI(c)$ at a given level c to the evaluation length

$$P_{mr}(c), R_{mr}(c), W_{mr}(c) = \frac{MI(c)}{l_n}$$

Section height difference of the primary profile $P_{\delta c}$

Section height difference of the roughness profile $R_{\delta c}$

Section height difference of the waviness profile $W_{\delta c}$

Vertical distance between two section levels of a given material ratio

$$R_{\delta c} = c(R_{mr1}) - c(R_{mr2}); R_{mr1} < R_{mr2}$$

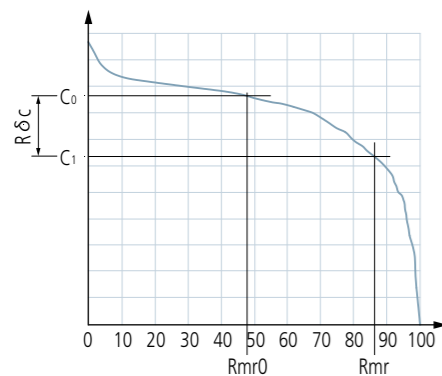

Relative material ratio of the primary profile P_{mr}

Relative material ratio of the roughness profile R_{mr}

Relative material ratio of the waviness profile W_{mr}

Material ratio determined at a profile section level $R_{\delta c}$, related to the reference section level c_0

$$P_{mr}, R_{mr}, W_{mr} = P_{mr}(c_1), R_{mr}(c_1), W_{mr}(c_1)$$

where $c_1 = c_0 - R_{\delta c}$ ($P_{\delta c}, W_{\delta c}$)
 $c_0 = c$ ($P_{mr0}, R_{mr0}, W_{mr0}$)

Procedure for determining a sampling length if it is not specified

Fig.1 Procedure for determining the sampling length if it is not specified

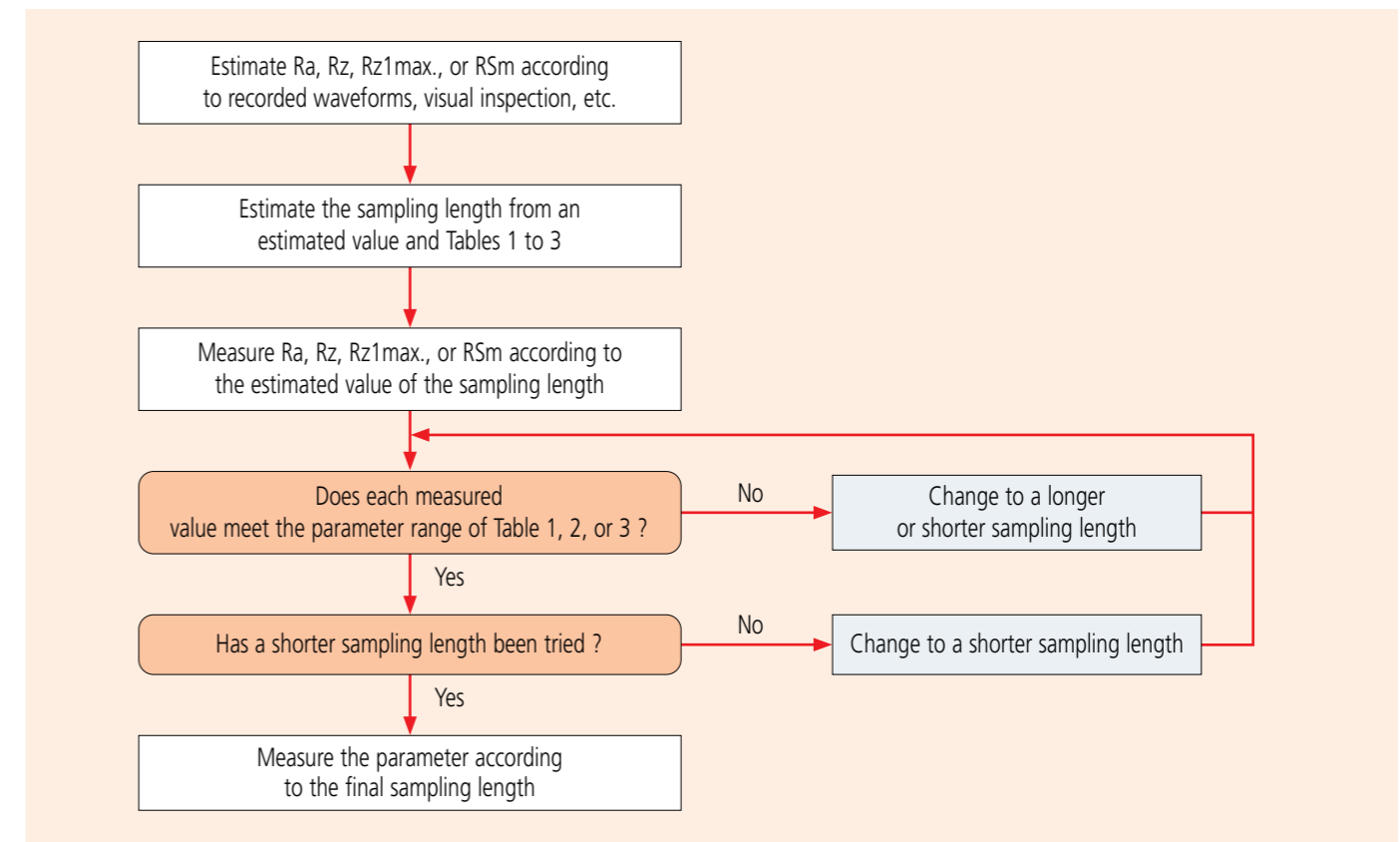
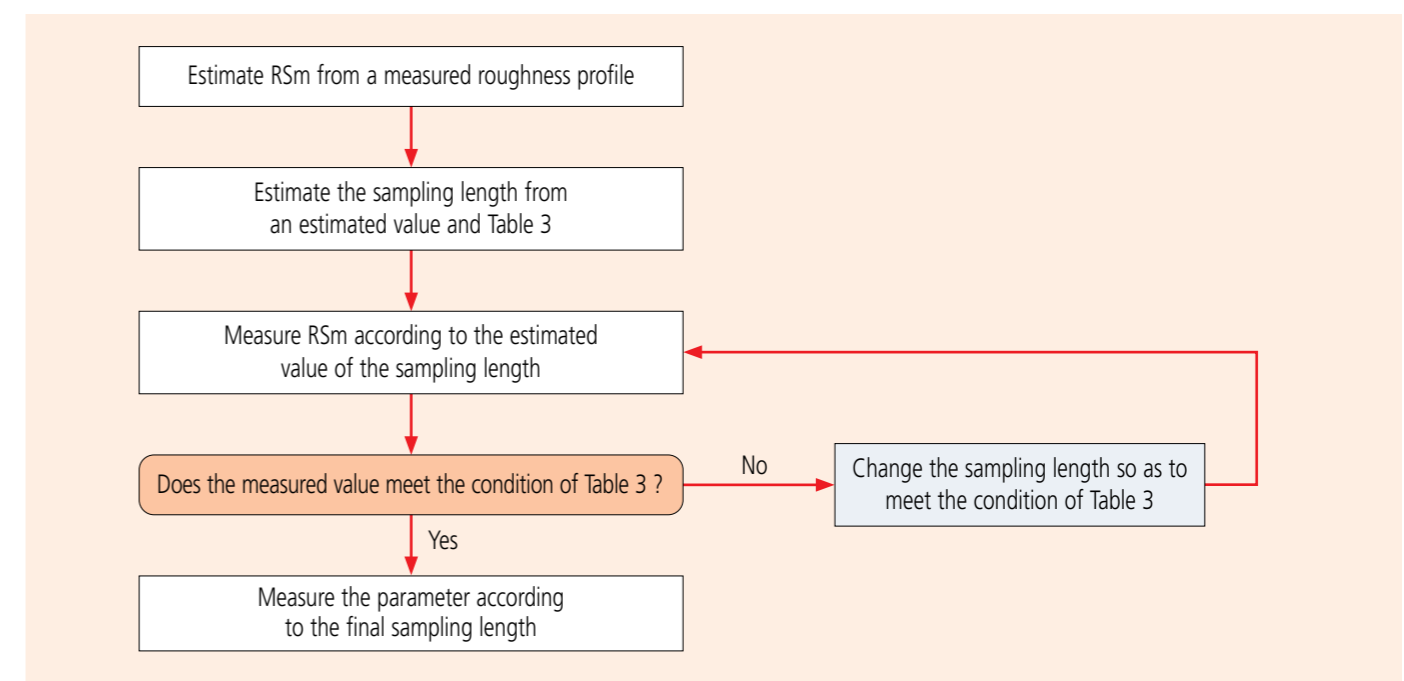

Fig.2 Procedure for determining the sampling length of a periodic profile if it is not specified.



Contracer (Contour Measuring Instruments)

Traceable Angle

The maximum angle at which a stylus can trace upwards or downwards along the contour of a workpiece, in the stylus travel direction, is referred to as the traceable angle. A one-sided sharp stylus with a tip angle of 12° (as in the above figure) can trace a maximum 77° of up slope and a maximum 87° of down slope. For a conical stylus (30° cone), the traceable angle is smaller. An up slope with an angle of 77° or less overall may actually include an angle of more than 77° due to the effect of surface roughness. Surface roughness also affects the measuring force.

For model CV-3200/4500, the same type of stylus (SPH-71: one-sided sharp stylus with a tip angle of 12°) can trace a maximum 77° of up slope and a maximum 83° of down slope.

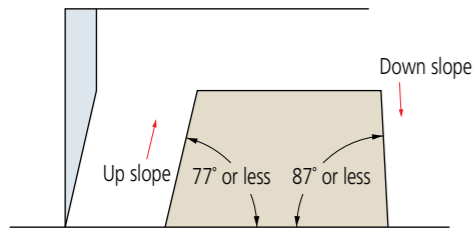

Compensating for Stylus Tip Radius

A recorded profile represents the locus of the center of the ball tip rolling on a workpiece surface. (A typical radius is 0.025 mm.) Obviously this is not the same as the true surface profile so, in order to obtain an accurate profile record, it is necessary to compensate for the effect of the tip radius through data processing.

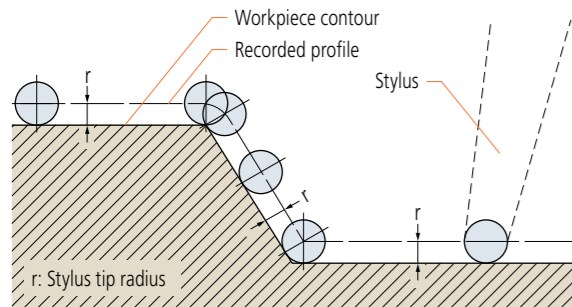

If a profile is read from the recorder through a template or scale, it is necessary to compensate for the stylus tip radius beforehand according to the applied measurement magnification.

Accuracy

As the detector units of the X and Z axes incorporate scales, the magnification accuracy is displayed not as a percentage but as the linear displacement accuracy for each axis.

Circular-Arc / Linear Tracing

The locus traced by the stylus tip during vertical stylus movement can be a circular arc or a straight line. Ensuring a straight-line locus entails complex mechanics, while in the case of a circular-arc locus, if the amplitude of stylus displacement is large in the vertical direction, an error (δ) in the recorded profile in the horizontal direction arises. (See figure at below)

Compensating for Arm Rotation

When the stylus traces through a circular-arc, error arises in the X-axis direction of the recorded profile. Possible methods for compensating for this effect are as follows:

1: Mechanical compensation

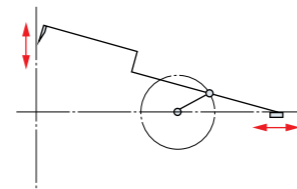

2: Electrical compensation

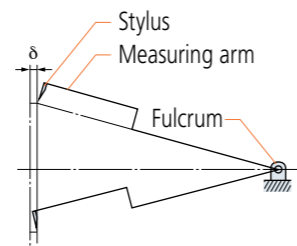

δ : Unwanted displacement in X to be compensated

3: Software processing. To measure a workpiece contour that involves a large displacement in the vertical direction with high accuracy, one of these compensation methods needs to be implemented.

Z axis Measurement Methods

Though the X axis measurement method commonly adopted is by means of a digital scale, the Z axis measurement divides into analog methods (using a differential transformer, for example) and digital scale methods. Analog methods vary in Z axis resolution depending on the measurement magnification and measuring range. Digital scale methods have fixed resolution.

Generally, a digital scale method provides higher accuracy than an analog method.

Overload Safety Cutout

If an excessive force (overload) is exerted on the stylus tip due, perhaps, to the tip encountering a too-steep slope on a workpiece feature, or a burr, etc., a safety device automatically stops operation and sounds an alarm buzzer. This type of instrument is commonly equipped with separate safety devices for the tracing direction (X axis) load and vertical direction (Z axis) load.

Contour analysis methods

You can analyze the contour with one of the following two methods after completing the measurement operation.

Data processing section and analysis program

The measured contour is input into the data processing section in real time and a dedicated program performs the analysis using the mouse and/or keyboard. The angle, radius, step, pitch and other data are directly displayed as numerical values. Analysis combining coordinate systems can be easily performed. The graph that goes through stylus radius correction is output to the printer as the recorded profile.

Best-fitting

If there is a standard for surface profile data, tolerancing with design data is performed according to the standard. If there is no standard, or if tolerancing only with shape is desired, best-fitting between design data and measurement data can be performed.

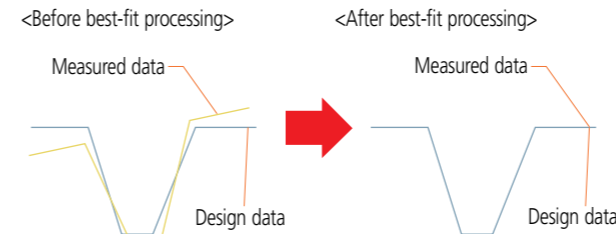

The best-fit processing algorithm searches for deviations between both sets of data and derives a coordinate system in which the sum of squares of the deviations is a minimum when the measured data is overlaid on the design data.

Tolerancing with Design Data

Measured workpiece contour data can be compared with design data in terms of actual and designed shapes rather than just analysis of individual dimensions. In this technique each deviation of the measured contour from the intended contour is displayed and recorded. Also, data from one workpiece example can be processed so as to become the master design data to which other workpieces are compared. This function is particularly useful when the shape of a section greatly affects product performance, or when its shape has an influence on the relationship between mating or assembled parts.

Data Combination

Conventionally, if tracing a complete contour is prevented by stylus traceable-angle restrictions then it has to be divided into several sections that are then measured and evaluated separately. This function avoids this undesirable situation by combining the separate sections into one contour by overlaying common elements (lines, points) onto each other. With this function the complete contour can be displayed and various analyses performed in the usual way.

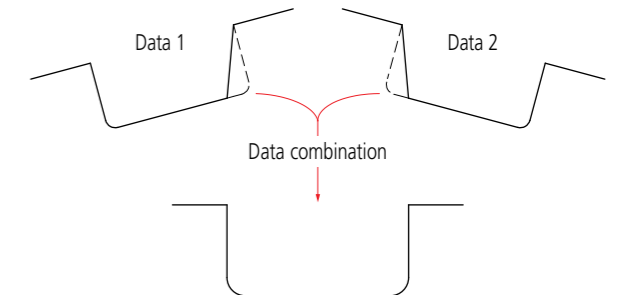

Measurement Examples



Aspheric lens contour



Inner/outer ring contour of a bearing



Internal gear teeth



Female thread form



Male thread form

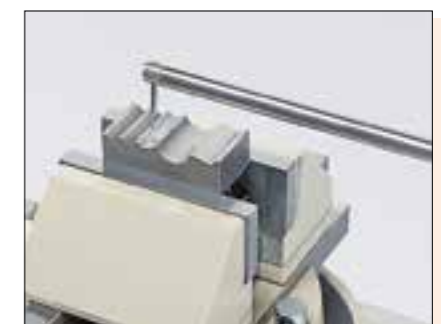

Gage contour

Roundtest (Roundform Measuring Instruments)

ISO 4291:1985 Methods for the assessment of departure from roundness -- Measurement of variations in radius

ISO 1101:2012 Geometrical product specifications (GPS) -- Geometrical tolerancing -- Tolerances of form, orientation, location and run-out

○ Roundness

Any circumferential line must be contained within the tolerance zone formed between two coplanar circles with a difference in radii of t

Notation example

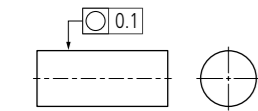

Tolerance zone

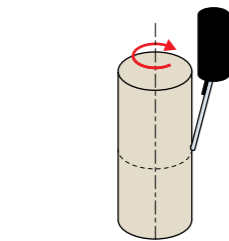
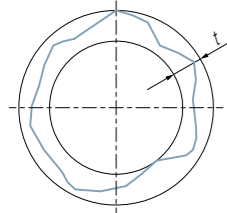

Verification example using a roundness measuring instrument

▭ Flatness

The surface must be contained within the tolerance zone formed between two parallel planes a distance t apart

Notation example

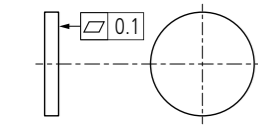

Tolerance zone

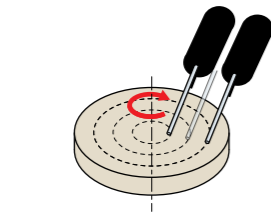
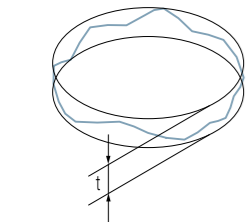

Verification example using a roundness measuring instrument

◎ Concentricity

The center point must be contained within the tolerance zone formed by a circle of diameter t concentric with the datum

Notation example

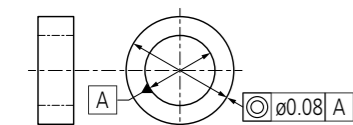

Tolerance zone

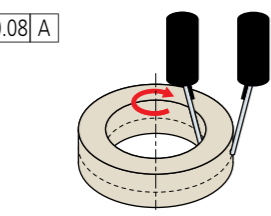
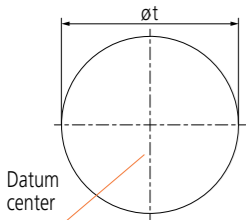

Verification example using a roundness measuring instrument

— Straightness

Any line on the surface must lie within the tolerance zone formed between two parallel straight lines a distance t apart and in the direction specified

Notation example

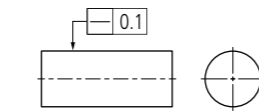

Tolerance zone

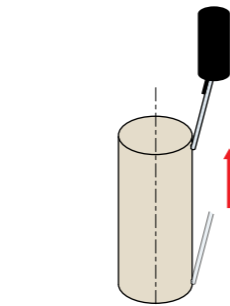

Verification example using a roundness measuring instrument

∕∕ Cylindricity

The surface must be contained within the tolerance zone formed between two coaxial cylinders with a difference in radii of t

Notation example

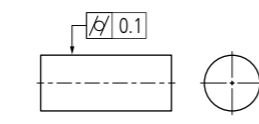

Tolerance zone

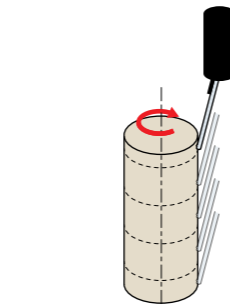
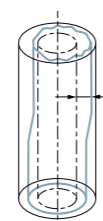

Verification example using a roundness measuring instrument

◎ Coaxiality

The axis must be contained within the tolerance zone formed by a cylinder of diameter t concentric with the datum

Notation example

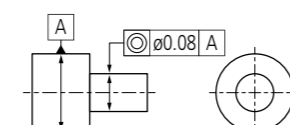

Tolerance zone

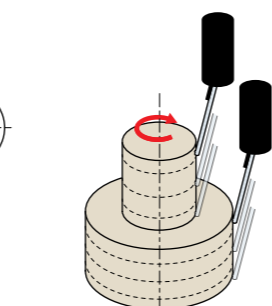
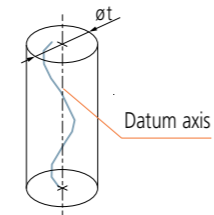

Verification example using a roundness measuring instrument

⊥ Perpendicularity

The line or surface must be contained within the tolerance zone formed between two planes a distance t apart and perpendicular to the datum

Notation example

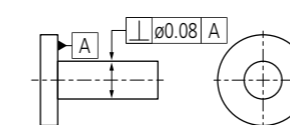

Notation example

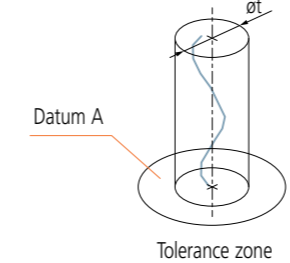

Datum A

Tolerance zone

Verification example using a roundness measuring instrument

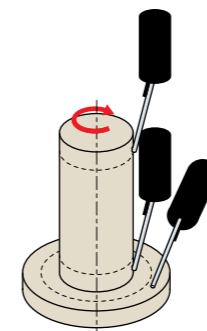

Notation example

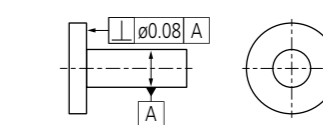

Notation example

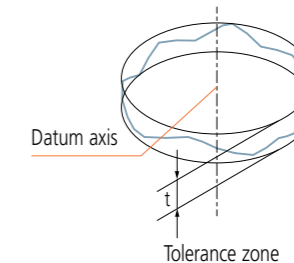

Datum axis

Tolerance zone

Verification example using a roundness measuring instrument

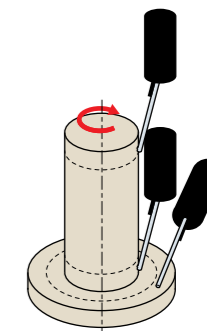

∕ Circular Runout (Radial and Axial)

The line must be contained within the tolerance zone formed between two coplanar and/or concentric circles a distance t apart concentric with or perpendicular to the datum

Specified direction: Radial direction Direction that intersects the datum axial straight line and is vertical to the datum axis line

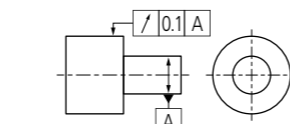

Notation example

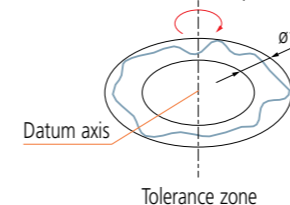

Datum axis

Tolerance zone

Verification example using a roundness measuring instrument

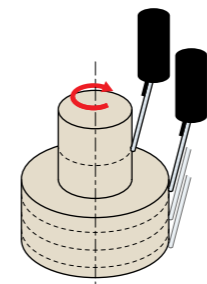

Specified direction: Radial direction Direction that intersects the datum axial straight line and is vertical to the datum axis line

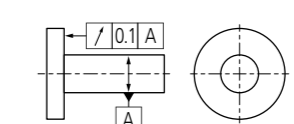

Notation example

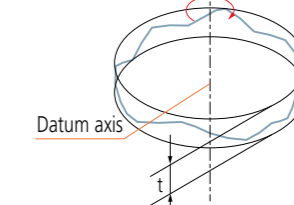

Datum axis

Tolerance zone

Verification example using a roundness measuring instrument

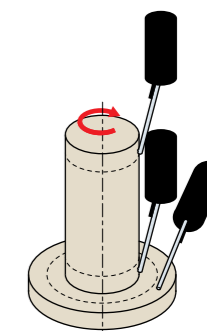

∕∕ Total Runout (Radial and Axial)

The surface must be contained within the tolerance zone formed between two coaxial cylinders with a difference in radii of t , or planes a distance t apart, concentric with or perpendicular to the datum

Specified direction: Radial direction Direction that intersects the datum axial straight line and is vertical to the datum axis line

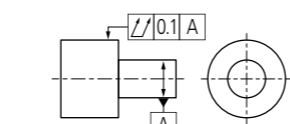

Notation example

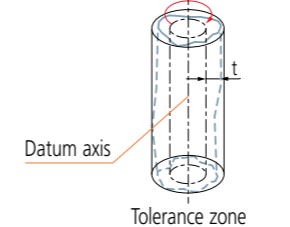

Datum axis

Tolerance zone

Verification example using a roundness measuring instrument

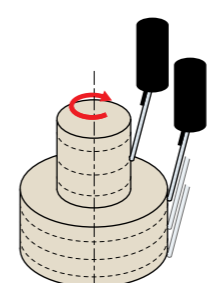

Specified direction: Radial direction Direction that intersects the datum axial straight line and is vertical to the datum axis line

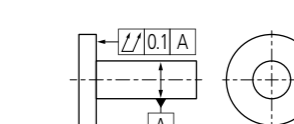

Notation example

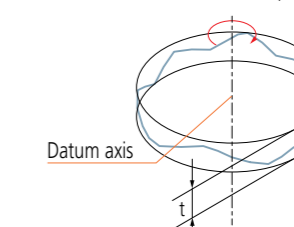

Datum axis

Tolerance zone

Verification example using a roundness measuring instrument

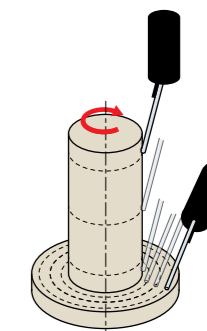

Roundtest (Roundform Measuring Instruments)

Adjustment prior to Measurement

ISO 4291:1985³

Centering

A displacement offset (eccentricity) between the Roundtest's turntable axis and that of the workpiece results in distortion of the measured form (limaçon error) and consequentially produces an error in the calculated roundness value. The larger the eccentricity, the larger is the error in calculated roundness.

Therefore the workpiece should be centered (axes made coincident) before measurement. Some roundness testers support accurate measurement with a limaçon error correction function. The effectiveness of this function can be seen in the graph below.

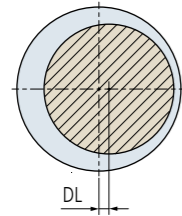

Leveling

Any inclination of the axis of a workpiece with respect to the rotational axis of the measuring instrument will cause an elliptic error. Leveling must be performed so that these axes are sufficiently parallel.

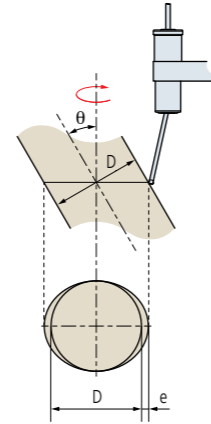

Effect of eccentricity compensation function

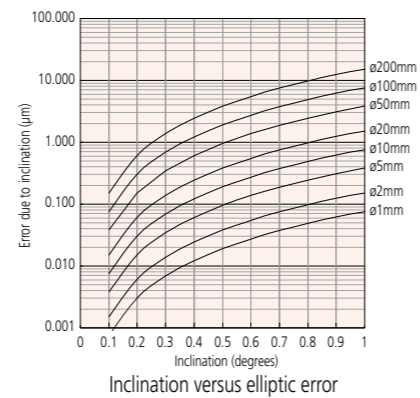
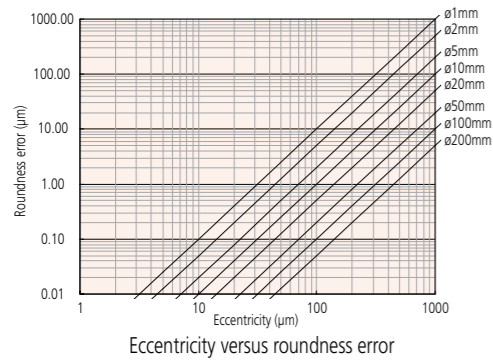

Evaluating the Measured Profile Roundness

Roundness testers use the measurement data to generate reference circles whose dimensions define the roundness value. There are four methods of generating these circles, as shown below, and each method has individual characteristics so the method that best matches the function of the workpiece should be chosen. Each method results in a different center position for the reference circles and therefore affects the axial location of the circular feature measured.

Least Square Circle (LSC)

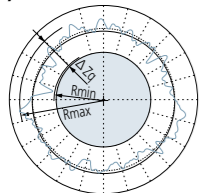

$\Delta Zq = R_{max} - R_{min}$
 ΔZq : A symbol indicating roundness value by LSC.

A circle is fitted to the measured profile such that the sum of the squares of the departure of the profile data from this circle is a minimum. The roundness figure is then defined as the maximum deviation of the profile from this circle (highest peak to the lowest valley).

Minimum Zone Circles (MZC)

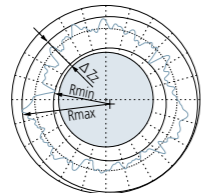

$\Delta Zz = R_{max} - R_{min}$
 ΔZz : A symbol indicating roundness value by MZC.

Two concentric circles are positioned to enclose the measured profile such that their radial difference is a minimum. The roundness figure is then defined as the radial separation of these two circles.

Minimum Circumscribed Circle (MCC)

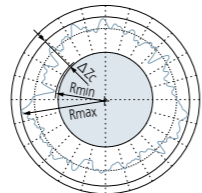

$\Delta Zc = R_{max} - R_{min}$
 ΔZc : A symbol indicating roundness value by MCC.

The smallest circle that can enclose the measured profile is created. The roundness figure is then defined as the maximum deviation of the profile from this circle. This circle is sometimes referred to as the 'ring gage' circle.

Maximum inscribed Circle (MIC)

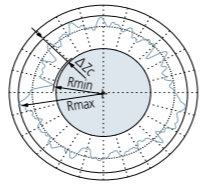

$\Delta Zi = R_{max} - R_{min}$
 ΔZi : A symbol indicating roundness value by MIC.

The largest circle that can be enclosed by the profile data is created. The roundness figure is then defined as the maximum deviation of the profile from this circle. This circle is sometimes referred to as the 'plug gage' circle.

Effect of Filter Settings on the Measured Profile

Profiles can be filtered in various ways to reduce or eliminate unwanted detail, with a cut-off value set in terms of undulations per revolution (upr). The effect of different upr settings is shown in the diagrams below, which illustrate how the measured roundness value decreases as lower upr settings progressively smooth out the line.

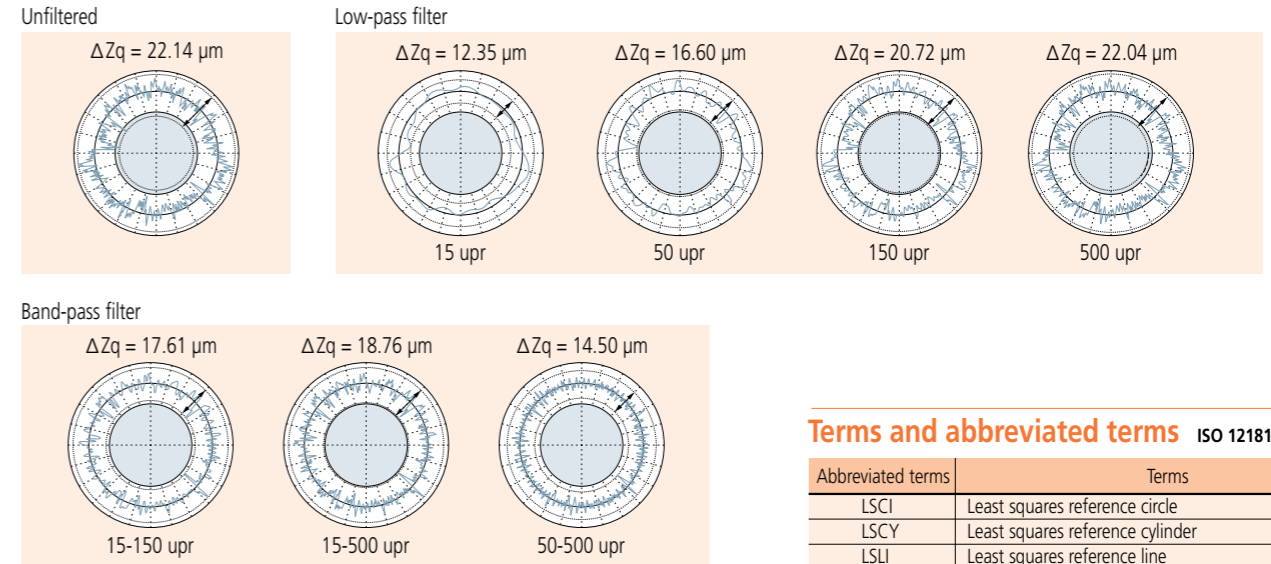

Evaluating the Measured Profile Roundness ISO 12181-1: 2011^{4,5}, ISO 4291: 1985³

Roundness testers use the measurement data to generate reference circles whose dimensions define the roundness value. There are four methods of generating these circles, as shown below, and each method has individual characteristics so the method that best matches the function of the workpiece should be chosen. Each method results in a different center position for the reference circles and therefore affects the axial location of the circular feature measured.

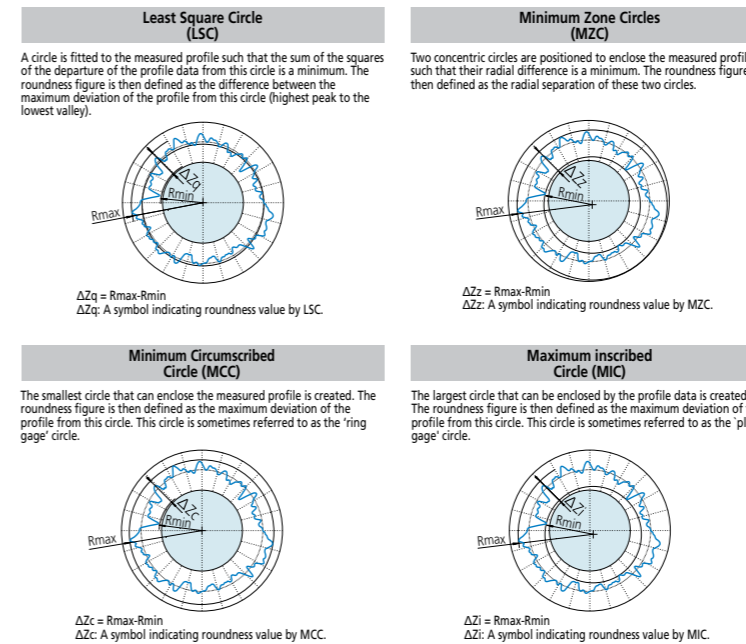

Filtering

	2CR filter	Gaussian filter
Standard	ISO 4291: 1985 ³	ISO 12181-1: 2011 ^{4,5}
Attenuation rate	75 %	50 %

Terms and abbreviated terms ISO 12181-1: 2011^{4,5}

Abbreviated terms	Terms
LSCI	Least squares reference circle
LSCY	Least squares reference cylinder
LSLI	Least squares reference line
LSPL	Least squares reference plane
LCD	Local cylindricity deviation
LFD	Local flatness deviation
LRD	Local roundness deviation
LSD	Local straightness deviation
MICI	Maximum inscribed reference circle
MICY	Maximum inscribed reference cylinder
MCCI	Minimum circumscribed reference circle
MCCY	Minimum circumscribed reference cylinder
MZCI	Minimum zone reference circles
MZCY	Minimum zone reference cylinder
MZLI	Minimum zone reference lines
MZPL	Minimum zone reference planes
UPR	Undulations per revolution

Parameters and abbreviated terms ISO 12181-1: 2011^{4,5}

Abbreviated terms	Parameter	Reference element*			
		Minimum zone	Least square	Minimum circumscribed	Minimum inscribed
CYLtt	Cylinder taper		✓		
STRsq	Generatrix straightness deviation		✓		
STRlc	Local generatrix straightness deviation		✓		
CYLp	Peak-to-reference cylindricity deviation		✓		
FLTp	Peak-to-reference flatness deviation		✓		
RONp	Peak-to-reference roundness deviation		✓		
STRp	Peak-to-reference straightness deviation		✓		
CYLt	Peak-to-valley cylindricity deviation	✓	✓	✓	✓
FLTt	Peak-to-valley flatness deviation	✓	✓		
RONt	Peak-to-valley roundness deviation	✓	✓	✓	✓
STRt	Peak-to-valley straightness deviation	✓	✓		
CYLv	Reference-to-valley cylindricity deviation		✓		
FLTv	Reference-to-valley flatness deviation		✓		
RONv	Reference-to-valley roundness deviation		✓		
STRv	Reference-to-valley straightness deviation		✓		
CYLq	Root-mean-square cylindricity deviation		✓		
FLTq	Root-mean-square flatness deviation		✓		
RONq	Root-mean-square roundness deviation		✓		
STRq	Root-mean-square straightness deviation		✓		
STRsa	Straightness deviation of the extracted median line	✓	✓	✓	✓

* The reference elements to which the parameter can be applied.

¹ ISO/DIS 1101: 1996 Geometrical Product Specifications (GPS) - Geometrical tolerancing - Tolerancing of form, orientation, location and run-out

² ISO 5459 Technical drawings - Geometrical tolerancing - Datums and datum-systems for geometrical tolerances

³ ISO 4291: 1985 Methods for the assessment of departure from roundness - Measurement of variations in radius

⁴ ISO 12181-2: 2011 Geometrical Product Specifications (GPS) - Roundness - Part 2: Specification operators

⁵ ISO 12181-1: 2011 Geometrical Product Specifications (GPS) - Roundness - Part 1: Vocabulary and parameters of roundness

Hardness Testing Machines

Methods of Hardness Measurement

(1) Vickers

Vickers hardness is a test method that has the widest application range, allowing hardness inspection with an arbitrary test force. This test has an extremely large number of application fields particularly for hardness tests conducted with a test force less than 9.807N (1 kgf). As shown in the following formula, Vickers hardness is a value determined by dividing test force F (N) by contact area S (mm²) between a specimen and an indenter, which is calculated from diagonal length d (mm, mean of two directional lengths) of an indentation formed by the indenter (a square pyramidal diamond, opposing face angle $\theta = 136^\circ$) in the specimen using a test force F (N). k is a constant ($1/g = 1/9.80665$).

$$HV = k \frac{F}{S} = 0.102 \frac{F}{S} = 0.102 \frac{2F \sin \frac{\theta}{2}}{d^2} = 0.1891 \frac{F}{d^2}$$

F: N
d: mm

The error in the calculated Vickers hardness is given by the following formula. Here, Δd_1 , Δd_2 , and 'a' represent the measurement error that is due to the microscope, an error in reading an indentation, and the length of an edge line generated by opposing faces of an indenter tip, respectively. The unit of $\Delta \theta$ is degrees.

$$\frac{\Delta HV}{HV} \approx \frac{\Delta F}{F} - 2 \frac{\Delta d_1}{d} - 2 \frac{\Delta d_2}{d} - \frac{a^2}{d^2} 3.5 \times 10^{-3} \Delta \theta$$

(2) Knoop

As shown in the following formula, Knoop hardness is a value obtained by dividing test force by the projected area A (mm²) of an indentation, which is calculated from the longer diagonal length d (mm) of the indentation formed by pressing a rhomboidal diamond indenter (opposing edge angles of $172^\circ 30'$ and 130°) into a specimen with test force F applied. Knoop hardness can also be measured by replacing the Vickers indenter of a microhardness testing machine with a Knoop indenter.

$$HK = k \frac{F}{A} = 0.102 \frac{F}{A} = 0.102 \frac{F}{cd^2} = 1.451 \frac{F}{d^2}$$

F: N
d: mm
c: Constant

(3) Rockwell and Rockwell Superficial

To measure Rockwell or Rockwell Superficial hardness, first apply a preload force and then the test force to a specimen and return to the preload force using a diamond indenter (tip cone angle: 120° , tip radius: 0.2 mm) or a sphere indenter (steel ball or carbide ball). This hardness value is obtained from the hardness formula expressed by the difference in indentation depth h (μm) between the preload and test forces. Rockwell uses a preload force of 98.07N, and Rockwell Superficial 29.42N. A specific symbol provided in combination with a type of indenter, test force, and hardness formula is known as a scale. Japanese Industrial Standards (JIS) define various scales of related hardness.

Relationship between Rockwell/Rockwell Superficial Hardness and the Minimum Allowable Thickness of a Specimen

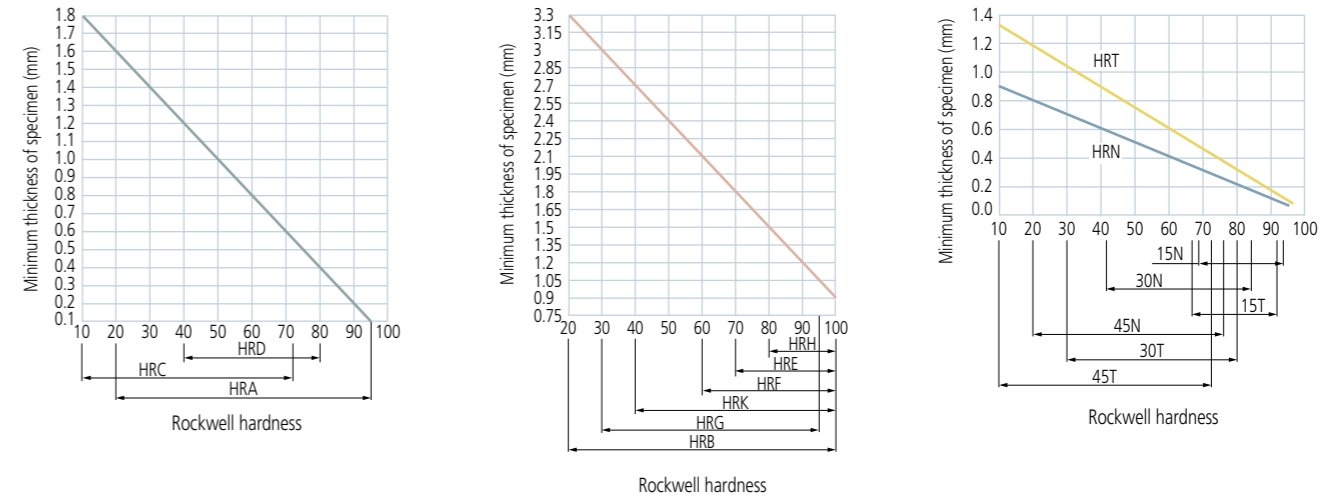

Rockwell Hardness Scales

Scale	Indenter	Test force (N)	Application
A	Diamond	588.4	Carbide, sheet steel
D		980.7	Case-hardened steel
C		1471	Steel (100 HRB or more to 70 HRC or less)
F	Ball with a diameter of 1.5875 mm	588.4	Bearing metal, annealed copper brass
B		980.7	Hard aluminum alloy, beryllium copper, phosphor bronze
G		1471	
H	Ball with a diameter of 3.175 mm	588.4	Bearing metal, grinding wheel
E		980.7	Bearing metal
K		1471	Bearing metal
L	Ball with a diameter of 6.35 mm	588.4	Plastic, lead
M		980.7	
P		1471	
R	Ball with a diameter of 12.7 mm	588.4	plastic
S		980.7	
V		1471	

Rockwell Superficial Hardness Scales

Scale	Indenter	Test force (N)	Application
15N	Diamond	147.1	Thin surface-hardened layer on steel such as carburized or nitrided
30N		294.2	
45N		441.3	
15T	Ball with a diameter of 1.5875 mm	147.1	Sheet of mild steel, brass, bronze, etc.
30T		294.2	
45T		441.3	
15W	Ball with a diameter of 3.175 mm	147.1	Plastic, zinc, bearing alloy
30W		294.2	
45W		441.3	
15X	Ball with a diameter of 6.35 mm	147.1	Plastic, zinc, bearing alloy
30X		294.2	
45X		441.3	
15Y	Ball with a diameter of 12.7 mm	147.1	Plastic, zinc, bearing alloy
30Y		294.2	
45Y		441.3	

Relationship between Vickers Hardness and the Minimum Thickness of a Specimen

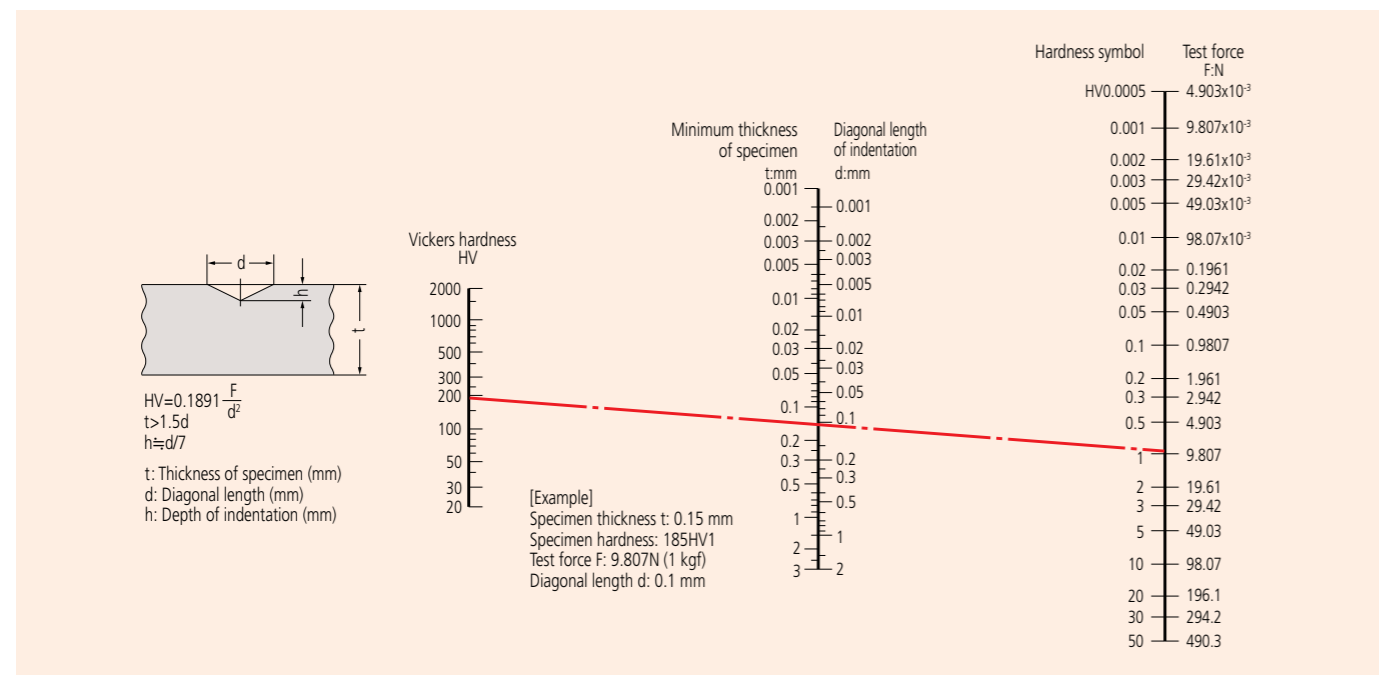

Coordinate Measuring Machines

Mitutoyo coordinate measuring machines use four structure types that provide the benefits of excellent stability, high accuracy, high measuring speed, convenience of workpiece clamping, etc.

Moving-Bridge Type CMM

This type is configured with the vertically moving ram (Z axis) mounted on a carriage, the carriage (X axis) horizontally moving on a bridge structure that is supported by the base and guided horizontally to form the Y axis. A workpiece is loaded on the base.

Many Mitutoyo CMM models have adopted this type of structure, achieving high accuracy, high speed and high acceleration. Mitutoyo offers a strong lineup of CMMs of this type from compact models through to the largest sizes found in the inspection room.

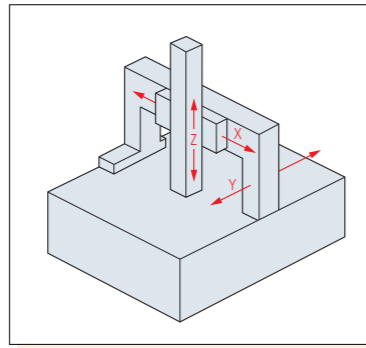

Fixed-Bridge Type CMM

This type is configured with the vertically moving ram (Z axis) mounted on a carriage, the carriage (X axis) moving horizontally on a bridge structure fixed to the base and a table (Y axis) moving horizontally on the base. A workpiece is loaded on the moving table.

Mitutoyo's Ultrahigh-accuracy CNC CMM LEGEX Series has adopted this structure type, providing the world's highest accuracy by minimizing error sources through exhaustive investigation and analysis.

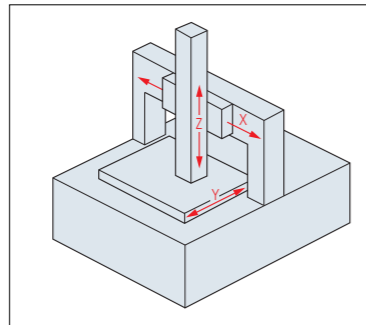

Horizontal-Arm Type CMM

This type is configured with the horizontally moving ram (Z axis) mounted on a carriage, the carriage (Y axis) vertically moving on a column supported by the base and the column (X axis) moving horizontally on the base. A workpiece is loaded on the base.

Mitutoyo In-line Type CNC CMM MACH-3A Series has adopted this structure type, attaining high-speed positioning, space-saving and durability to be compatible with line-side / in-line installation.

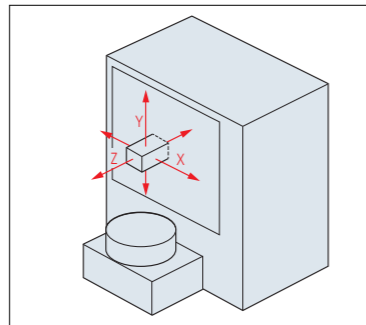

Bridge / Floor Type CMM

This type is configured with the vertically moving ram (Z axis) mounted on a carriage, the carriage (X axis) moving horizontally on a double bridge structure (Y axis) that is supported on a hard floor. A workpiece is set down directly on the floor.

Mitutoyo's Ultralarge Separate Guide CNC CMM has adopted this type that incorporates Mitutoyo's original structure (moving bridge on-floor installation type). It allows high-accuracy measurement of a large, heavy workpiece, featuring the world's largest measuring range.

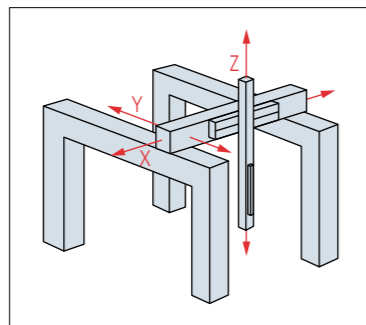

Performance Assessment Method of Coordinate Measuring Machines

Regarding the performance assessment method of CMM, a revision of ISO 10360 series was issued in 2003, and was partially revised in 2009. The following describes the standard inspection method including the revised content.

Table 1 ISO 10360 series

Item	ISO Standard No.	Year of issue
1 Terms	ISO 10360-1	2000
2 Length measurement	ISO 10360-2	2009
3 Rotary table equipped CMM	ISO 10360-3	2000
4 Scanning measurement	ISO 10360-4	2000
5 Single/Multi-styli measurement	ISO 10360-5	2010
6 Software inspection	ISO 10360-6	2001

Maximum permissible length measurement error $E_{0,MPE}$ [ISO 10360-2:2009]

Using the standard CMM with specified probe, measure 5 different calibrated lengths 3 times each in 7 directions within the measuring volume (as indicated in Figure 1), making a total of 105 measurements.

If these measurement results, including the allowance for the uncertainty of measurement, are equal to or less than the values specified by the manufacturer, then it proves that the performance of the CMM meets its specification.

The result of OK/NG is required to be judged considering the uncertainties.

The maximum permissible error (standard value) of the test may be expressed in any of the following three forms (unit: μm).

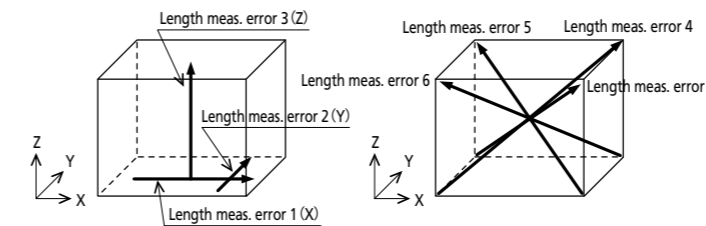

Figure 1 Measuring directions to obtain length measurement error

$$E_{0,MPE} (MPE_e) = A + L/K \leq B$$

$$E_{0,MPE} (MPE_e) = A + L/K$$

$$E_{0,MPE} (MPE_e) = B$$

A: Constant (μm) specified by the manufacturer
 K: Dimensionless constant specified by the manufacturer
 L: Measured length (mm)
 B: Upper limit value (μm) specified by the manufacturer

Note: ISO 10360-2:2009 requires measurement in 4 different directions and recommends measurement parallel to each axis, while ISO 10360-2:2001 specified the measurement "in arbitrary 7 directions."

The following error definitions were added in ISO 10360-2:2009.

Maximum Permissible Length Measurement Error / Length Measurement Error when Z-axis stylus offset is 150 mm $E_{150,MPE}$ [ISO 10360-2:2009]

In addition to length measurement in 7 directions, ISO 10360-2:2009 specifies measuring in 2 lines over the diagonal YZ or XZ plane with probe offset.

Note: The stylus offset is set at 150 mm as default.

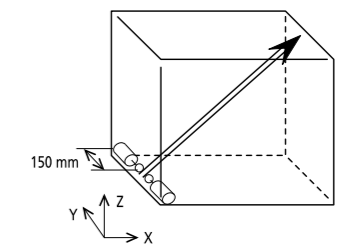

Figure 2 Length measurement error when Z-axis stylus offset is 150mm

Maximum Permissible Limit of the Repeatability Range of Length Measurement $R_{0,MPL}$ [ISO 10360-2:2009]

Calculate the maximum value from the results of three repeated measurements.

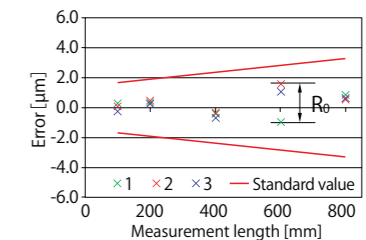

Figure 3 Repeating range of length measurement

Maximum Permissible Radial Four-Axis Error MPE_{FR} , Maximum Permissible Tangential Four-Axis Error MPE_{FT} , and Maximum Permissible Axial Four-Axis Error MPE_{FA} [ISO 10360-3:2000]

The test procedure under this standard is to place two standard spheres on the rotary table as shown in Figure 4. Rotate the rotary table to a total of 15 positions including 0°, 7 positions in the plus (+) direction, and 7 positions in the minus (-) direction and measure the center coordinates of the two spheres in each position. Then, add the uncertainty of the standard sphere shape to each variation (range) of radial direction elements, connecting direction elements, and rotational axis direction elements of the two standard sphere center coordinates. If these calculated values are less than the specified values, the evaluation test is passed.

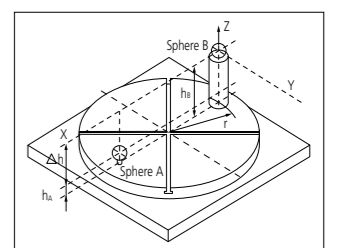

Figure 4 Evaluation of a CMM with a rotary table

Coordinate Measuring Machines

Maximum Permissible Scanning Probing Error MPE_{THP} [ISO 10360-4:2000]

This is the accuracy standard for a CMM if equipped with a scanning probe. The test procedure under this standard is to perform a scanning measurement in 4 planes on the standard sphere and then, for the least squares sphere center calculated using all the measurement points, calculate the radial range (dimension 'A' in Figure 5) within which all measurement points exist. Based on the least squares sphere center calculated above, calculate the radial distance between the calibrated standard sphere radius and the maximum measurement point and the minimum measurement point, and take the larger distance (dimension 'B' in Figure 5). Add an extended uncertainty that combines the uncertainty of the stylus tip shape and the uncertainty of the standard test sphere shape to each A and B dimension. If both calculated values are less than the specified values, this scanning probe test is passed.

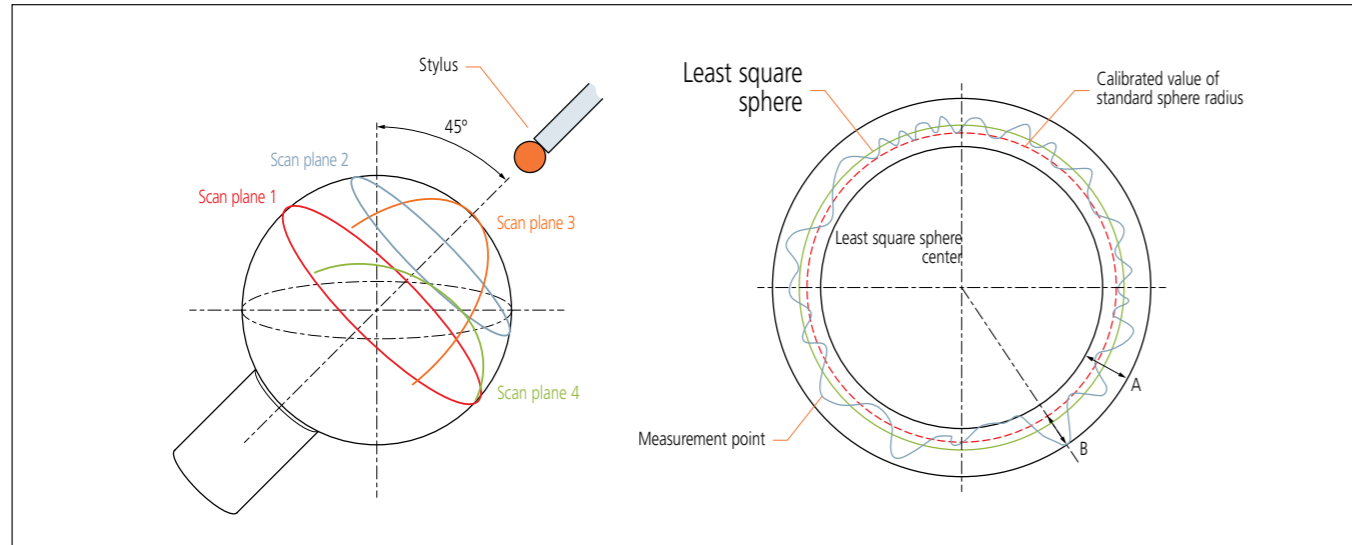

Figure 5 Target measurement planes for the maximum permissible scanning probing error and its evaluation concept

Maximum Permissible Single Stylus Form Error $P_{FTU, MPE}$ [ISO 10360-5:2010]

This measurement was included in the dimensional measurement in ISO 10360-2:2001. However, it is specified as "CMMs using single and multiple stylus contacting probing systems" in ISO 10360-5:2010.

The measurement procedure has not been changed, and the following should be performed.

Measure the defined target points on a standard sphere (25 points, as in Figure 6) and use all the results to calculate the center position of the sphere by a least squares method.

Then, calculate the distance R from the center position of the sphere by a least squares method for each of the 25 measurement points, and obtain the radius difference $R_{max} - R_{min}$. If the radius difference, to which a compound uncertainty of forms of the stylus tip and the standard test sphere are added, is equal to or less than the specified value, it can be judged that the probe has passed the test.

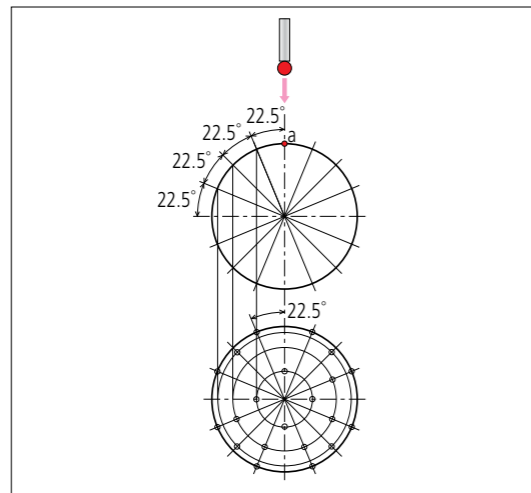

Figure 6 Target points for determining the Maximum Permissible Probing Error

Measurement Uncertainty of CMM

Measurement uncertainty is an indication used for evaluating reliability of measurement results.

In ISO 14253-1:1998, it is proposed to consider the uncertainty when evaluating the measurement result in reference to the specification.

However, it is not easy to estimate the uncertainty of the measurement performed by a CMM.

To estimate the uncertainty of the measurement, it is necessary to quantify each source of uncertainty, and determine how it propagates to the measurement result. The CMM is subject to all types of settings that determine how the measurement should be performed, such as measurement point distribution, or datum definition, according to the drawing instruction or operator's intention. This feature makes it harder to detect the source of uncertainty influencing the result. Taking circle measurement as an example, just a difference of one measurement point and its distribution causes the necessity of recalculation of the uncertainty. Also, there are many sources of uncertainty to be considered with the CMM and their interactions are complex.

Because of the above, it is almost impossible to generalize on how to estimate measurement uncertainty of the CMM.

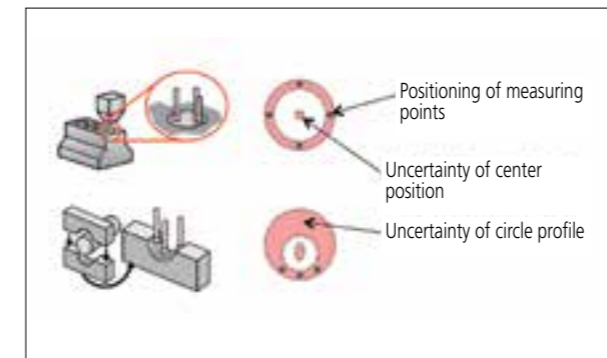

Example of circle measurement by CMM

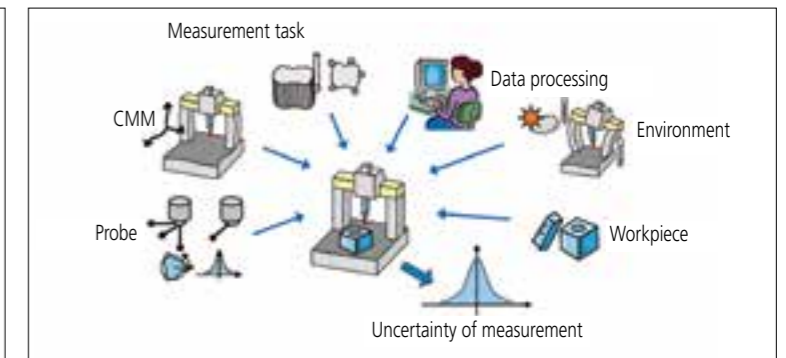

Major contributions that cause uncertainty in CMM measurement results

Measurement uncertainty of the CMM and the Virtual CMM software

The Virtual CMM software* enables straightforward, automated estimation of the measurement uncertainty of a CMM. The software simulates a CMM on a PC based on its machine characteristics and performs virtual (simulated) measurements. The simulated measurements are performed according to the part program created by the machine operator. The machine's performance is evaluated from experimental values based on geometrical characteristics of the actual machine, probing characteristics, and temperature environment, etc., and the measurement uncertainty of the CMM is estimated by the software package.

ISO15530 Part 4 (ISO / TS 15530-4 (2008)) defines how to verify the validity of task-specific measurement uncertainty using computer simulations.

Virtual CMM conforms to this specification.

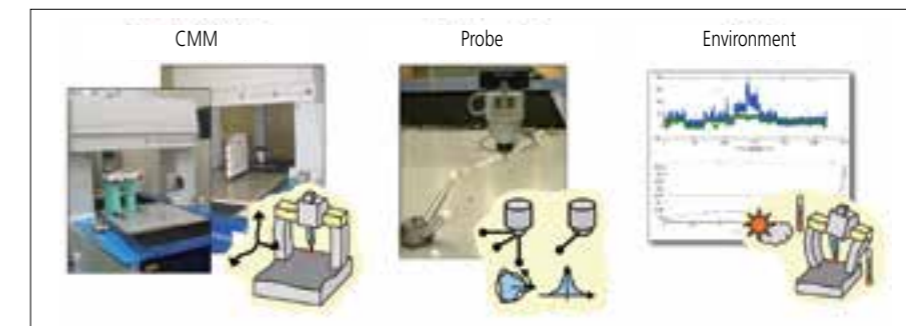

Quantification of CMM uncertainty elements by experiment

Note: Virtual CMM is a software package originally developed by PTB (Physikalisch-Technische Bundesanstalt).

Relevant parts of ISO15530: Geometrical Product Specifications (GPS) – Coordinate measuring machines (CMM): Technique for determining the uncertainty of measurement –

Part 3: Use of calibrated workpieces or measurement standards

Part 4: Evaluating task-specific measurement uncertainty using simulation [Technical Specification]

**Quick Guide to Precision Measuring Instruments
No. E11003(6)**

Issued in December, 2021

Issued by Mitutoyo Corporation

20-1, Sakado-1Chome, Takatsu-ku, Kawasaki-shi,
Kanagawa 213-8533, Japan

Our products are classified as regulated items under Japanese Foreign Exchange and Foreign Trade Law. Please consult us in advance if you wish to export our products to any other country.

If the purchased product is exported, even though it is not a regulated item (Catch-All controls item), the customer service available for that product may be affected. If you have any questions, please consult your local Mitutoyo sales office.



Mitutoyo Corporation

20-1, Sakado 1-Chome, Takatsu-ku, Kawasaki-shi,
Kanagawa 213-8533, Japan
<https://www.mitutoyo.co.jp>

