

Inside Diameter Measurement Bore Gage

Catalog No.E3051-511



Best-selling range of bore gages now offers better accuracy,
user-friendliness and durability

Mitutoyo

Bore Gage

NEW



The Best-Selling Inside Diameter Measurement Tools are now

**More Accurate,
More Easily Used,
More Durable!**

1 All models now more accurate

The measurement accuracy of new models has improved by 50% or more compared with their predecessors (in JIS standard values).

Wide-range accuracy:
Improved from 5 μm to 2 μm
Repeatability: Improved from 2 μm to 0.5 μm
Adjacent error: Improved from 2 μm to 1 μm



2 33% longer plunger stroke

The plunger stroke of flagship models has expanded from 1.2mm to 1.6mm, still maintaining the stated accuracy.

(For information about compatible models, refer to the specification of each model on pages 4 and 6.)

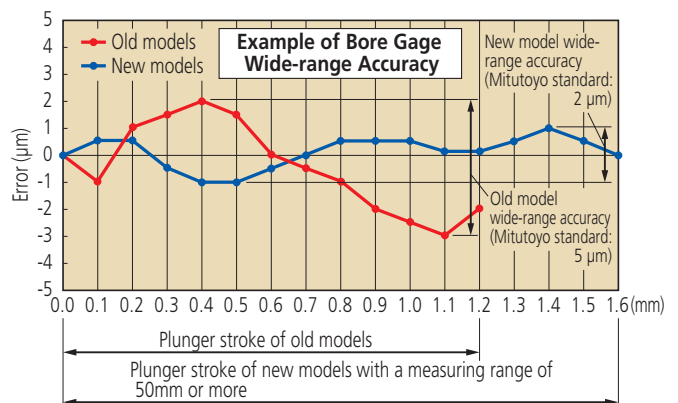
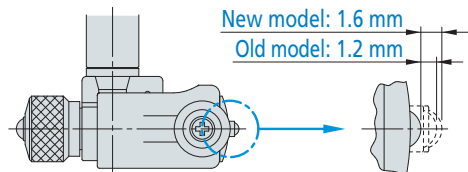

Standard bore gage

Bore gage with micrometer head

Mitutoyo

Nakatsugawa Plant Dedicated to the Manufacture of Sensors

The Nakatsugawa Plant was established in 1997 as the twelfth Mitutoyo plant in Japan and is located in a beautiful natural environment within the central industrial complex of Nakatsugawa City, Gifu Prefecture. It is dedicated to sensor manufacture and incorporates an integrated production system from design to manufacture of measuring instruments such as dial gages, test indicators, digimatic indicators and bore gages. Leading-edge production technologies and facilities ensure that the Mitutoyo-brand instruments shipped from here are highly valued as the world's best, providing users with a strong feeling of confidence.



3 Carbide contact-tips and anvils

The new carbide-ball contact point and anvil tip have increased abrasion resistance compared with the steel-ball type and better surface roughness compared with the molded carbide-tip type. Thus, they almost never scratch a workpiece.

Improved abrasion resistance over a steel-ball type



Test method

- Rotating a sandpaper-wrapped cylinder against the ball tip.

Sandpaper: 9 μm grit size
Load: 0.5N (50g)
Sliding distance: 1,000m



Much less damage to soft materials

Old carbide tip (molded part)

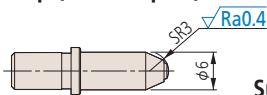

Surface profile of specimen after test

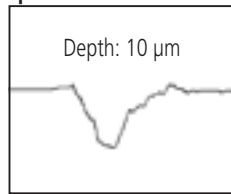

New type carbide ball-tip

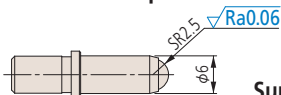

Surface profile of specimen after test

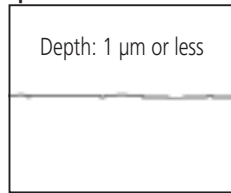

Test method

- Reciprocating the tip 20 times on an aluminum plate under a load of 4N

4 New grip improves accuracy during prolonged use

(Design registered in Japan)

This model reduces the influence of heat from the operator's hand by 50% by increasing the grip size and making the grip hollow-structured, thereby retaining high-accuracy measurement.

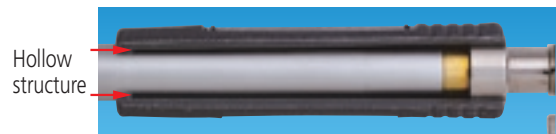

The length below the grip is the same as that of the old model. This guarantees no difference in operability of the gage.

(Note: The overall length of this model is longer than that of its predecessor and therefore may not fit in an existing custom-made storage box.)

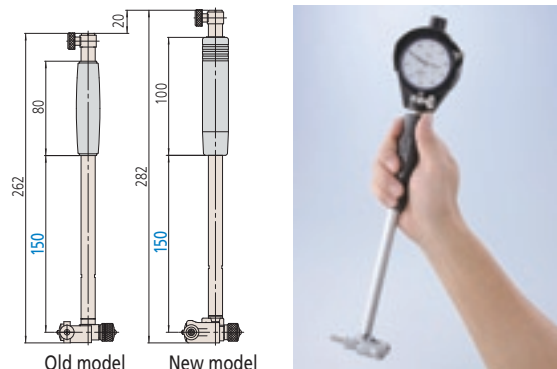

5 New contacts mean smoother action and better durability



Comparison of measuring force between the new and old models (50-to-150mm models)

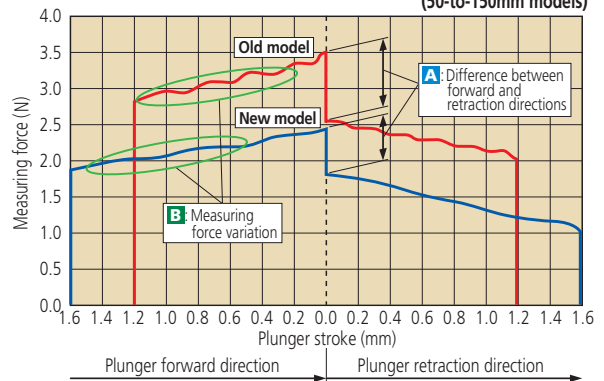

- A:** The new models provide a minimum difference in measuring force between the forward and retraction directions, thus achieving smooth operation and high durability.
- B:** The new models enable stable measurement by reducing the variation of measuring force.

Series 511

Standard Bore Gage

Short-leg Bore Gage

Accuracy

- Wide-range accuracy: 2 μm
- Repeatability: 0.5 μm
- Adjacent error: 1 μm



Standard Bore Gage



511-703



Short-leg Bore Gage



511-764

Measuring Heads

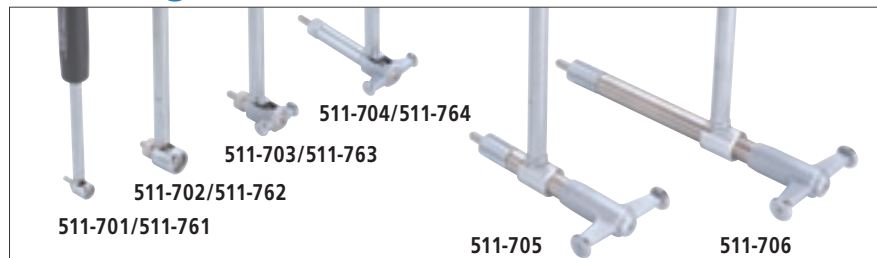

Specifications

• Metric

Code No.	Type	Measuring range	Effective stroke of plunger	Measuring force	Guide force	Number of anvils	Number of adjustment spacers	Sub-anvil	Mass Net
511-701	Standard	18-35mm	1.2mm	4N or less	6N or less	9 pcs	2 pcs	—	160g
511-761	Short-leg					6 pcs			150g
511-702	Standard	35-60mm	1.6mm	5N or less	10N or less	6 pcs	4 pcs	1 pcs (50mm)	230g
511-762	Short-leg					11 pcs			210g
511-703	Standard	50-150mm	1.6mm	5N or less	10N or less	11 pcs	4 pcs	1 pcs (50mm)	250g
511-763	Short-leg					13 pcs			230g
511-704	Standard	100-160mm	1.6mm	6N or less	15N or less	6 pcs	7 pcs	—	310g
511-764	Short-leg					5 pcs			290g
511-705	Standard	160-250mm	1.6mm	6N or less	15N or less	6 pcs	7 pcs	—	680g
511-706	Standard	250-400mm	1.6mm	6N or less	15N or less	5 pcs	7 pcs	1 pcs (75mm)	775g

• Inch

Code No.	Type	Measuring range	Effective stroke of plunger	Measuring force	Guide force	Number of anvils	Number of adjustment spacers	Sub-anvil	Mass Net
511-731	Standard	.7" - 1.4"	.047"	4N or less	6N or less	9 pcs	2 pcs	—	160g
511-781	Short-leg					6 pcs			150g
511-732	Standard	1.4" - 2.5"	.063"	5N or less	10N or less	6 pcs	4 pcs	1 pcs (2")	230g
511-782	Short-leg					11 pcs			210g
511-733	Standard	2" - 6"	.063"	5N or less	10N or less	11 pcs	4 pcs	1 pcs (2")	250g
511-783	Short-leg					13 pcs			230g
511-734	Standard	4" - 6.5"	.063"	6N or less	15N or less	6 pcs	7 pcs	—	310g
511-784	Short-leg					5 pcs			290g
511-735	Standard	6.5" - 10"	.063"	6N or less	15N or less	6 pcs	7 pcs	—	680g
511-736	Standard	10" - 16"	.063"	6N or less	15N or less	5 pcs	7 pcs	1 pcs (3")	775g

*It is not permissible to use a sub-anvil other than as supplied as a standard accessory, or widen a measuring range by using multiple sub-anvils. (The measurement accuracy in such cases is not guaranteed.)

Main Standard Accessories

•Metric

Type	Code No.	Dial gage	Dial protection Cover Ass'y
Standard	511-701	Not attached	Not attached
	511-711	2046SB	21DZA000
	511-721	2109SB-10	
	511-702	Not attached	Not attached
	511-712	2046SB	21DZA000
	511-722	2109SB-10	
	511-703	Not attached	Not attached
	511-713	2046SB	21DZA000
	511-723	2109SB-10	
	511-704	Not attached	Not attached
	511-714	2046SB	21DZA000
	511-724	2109SB-10	
	511-705	Not attached	Not attached
	511-715	2046SB	21DZA000
	511-725	2109SB-10	
	511-706	Not attached	Not attached
511-716	2046SB	21DZA000	
511-726	2109SB-10		
Short-leg	511-761	Not attached	Not attached
	511-766	2046SB	21DZA000
	511-771	2109SB-10	
	511-762	Not attached	Not attached
	511-767	2046SB	21DZA000
	511-772	2109SB-10	
	511-763	Not attached	Not attached
	511-768	2046SB	21DZA000
	511-773	2109SB-10	
	511-764	Not attached	Not attached
511-769	2046SB	21DZA000	
511-774	2109SB-10		

•Inch

Type	Code No.	Dial gage	Dial protection Cover Ass'y	
Standard	511-731	Not attached	Not attached	
	511-741	2922SB	21DZA000	
	511-751	2923SB-10		
	511-732	Not attached	Not attached	
	511-742	2922SB	21DZA000	
	511-752	2923SB-10		
	511-733	Not attached	Not attached	
	511-743	2922SB	21DZA000	
	511-753	2923SB-10		
	511-734	Not attached	Not attached	
	511-744	2922SB	21DZA000	
	511-754	2923SB-10		
	511-735	Not attached	Not attached	
	511-745	2922SB	21DZA000	
	511-755	2923SB-10		
	511-736	Not attached	Not attached	
	511-746	2922SB	21DZA000	
	511-756	2923SB-10		
	Short-leg	511-781	Not attached	Not attached
		511-786	2922SB	21DZA000
511-791		2923SB-10		
511-782		Not attached	Not attached	
511-787		2922SB	21DZA000	
511-792		2923SB-10		
511-783		Not attached	Not attached	
511-788		2922SB	21DZA000	
511-793		2923SB-10		
511-784		Not attached	Not attached	
511-789		2922SB	21DZA000	
511-794		2923SB-10		



511-921

•Metric

Code No.	Bore Gage	Indicator	Dial protection Cover Ass'y
511-921	511-701	2046SB	21DZA000
511-922	511-702	2109SB-10	
511-925	511-703	543-264B	



511-931

•Inch

Code No.	Bore Gage	Indicator	Dial protection Cover Ass'y
511-931	511-731	2922SB	21DZA000
511-932	511-732	2923SB-10	
511-935	511-733	543-266B	

Dimensions

Unit: mm

18-35mm/.7-1.4"

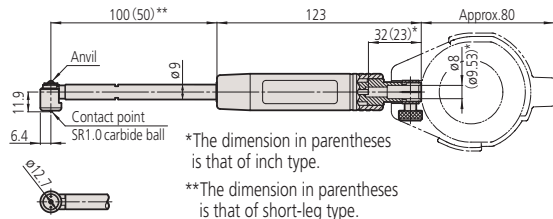

*The dimension in parentheses is that of inch type.

**The dimension in parentheses is that of short-leg type.

•Set of dial gage protective cover, retaining plate, and round-head Phillips screws: **No.21DZA000**

35-60mm/1.4-2.5", 50-150mm/2-6", 100-160mm/4-6.5"

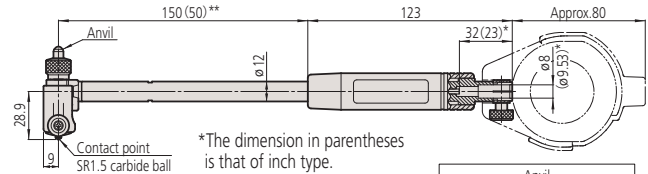

*The dimension in parentheses is that of inch type.

**The dimension in parentheses is that of short-leg type.

Code No.	A
511-703	38
511-704	50

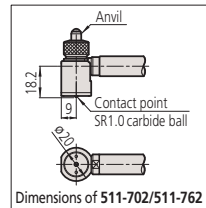

Dimensions of 511-702/511-762

Anvils

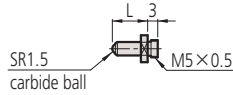

•Metric

Main unit	Marking	Size (mm)	L (mm)	Part No.
511-701 511-761	1	18	2.5	21DZA213A
	2	20	4.5	21DZA213B
	3	22	6.5	21DZA213C
	4	24	8.5	21DZA213D
	5	26	10.5	21DZA213E
	6	28	12.5	21DZA213F
	7	30	14.5	21DZA213G
	8	32	16.5	21DZA213H
	9	34	18.5	21DZA213J

•Inch

Main unit	Marking	Size (inch)	L (inch)	Part No.
511-731 511-781	1	.709	.098	21DZA213A
	2	.787	.177	21DZA213B
	3	.866	.256	21DZA213C
	4	.945	.335	21DZA213D
	5	1.024	.413	21DZA213E
	6	1.102	.492	21DZA213F
	7	1.181	.571	21DZA213G
	8	1.260	.650	21DZA213H
	9	1.339	.728	21DZA213J

Anvils

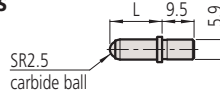

•Metric

Main unit	Marking	Size (mm)	L (mm)	Part No.
511-702 511-762	1	35	5.5	21DZA232A
	2	40	10.5	21DZA232B
	3	45	15.5	21DZA232C
	4	50	20.5	21DZA232D
	5	55	25.5	21DZA232E
	6	60	30.5	21DZA232F
511-703 511-763	1	50(100)	5.5	21DZA232A
	2	55(105)	10.5	21DZA232B
	3	60(110)	15.5	21DZA232C
	4	65(115)	20.5	21DZA232D
	5	70(120)	25.5	21DZA232E
	6	75(125)	30.5	21DZA232F
	7	80(130)	35.5	21DZA232G
	8	85(135)	40.5	21DZA232H
	9	90(140)	45.5	21DZA232J
	10	95(145)	50.5	21DZA232L
	11	100(150)	55.5	21DZA232M
511-704 511-764	1	100	5.5	21DZA232A
	2	105	10.5	21DZA232B
	3	110	15.5	21DZA232C
	4	115	20.5	21DZA232D
	5	120	25.5	21DZA232E
	6	125	30.5	21DZA232F
	7	130	35.5	21DZA232G
	8	135	40.5	21DZA232H
	9	140	45.5	21DZA232J
	10	145	50.5	21DZA232L
	11	150	55.5	21DZA232M
	12	155	60.5	21DZA232N
	13	160	65.5	21DZA232P

NOTE: Each dimension in parentheses is that of 511-703, indicating a size if the 50mm sub-anvil is used.

•Inch

Main unit	Marking	Size (inch)	L (inch)	Part No.
511-732 511-782	1	1.378	.217	21DZA232A
	2	1.575	.413	21DZA232B
	3	1.772	.610	21DZA232C
	4	1.969	.807	21DZA232D
	5	2.165	1.004	21DZA232E
	6	2.362	1.201	21DZA232F
511-733 511-783	1	1.969(3.969)	.217	21DZA232A
	2	2.165(4.165)	.413	21DZA232B
	3	2.362(4.362)	.610	21DZA232C
	4	2.559(4.559)	.807	21DZA232D
	5	2.756(4.756)	1.004	21DZA232E
	6	2.953(4.953)	1.201	21DZA232F
	7	3.150(5.150)	1.398	21DZA232G
	8	3.346(5.346)	1.594	21DZA232H
	9	3.543(5.543)	1.791	21DZA232J
	10	3.740(5.740)	1.988	21DZA232L
	11	3.937(5.937)	2.185	21DZA232M
511-734 511-784	1	3.937	.217	21DZA232A
	2	4.134	.413	21DZA232B
	3	4.331	.610	21DZA232C
	4	4.528	.807	21DZA232D
	5	4.724	1.004	21DZA232E
	6	4.921	1.201	21DZA232F
	7	5.118	1.398	21DZA232G
	8	5.315	1.594	21DZA232H
	9	5.512	1.791	21DZA232J
	10	5.709	1.988	21DZA232L
	11	5.906	2.185	21DZA232M
	12	6.102	2.382	21DZA232N
	13	6.299	2.579	21DZA232P

NOTE: Each dimension in parentheses is that of 511-733, indicating a size if the 2" sub-anvil is used.

Adjustment spacers

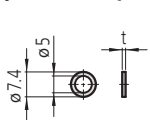

•Metric

t (mm)	Part No.
0.5	205623
1	205624

•Inch

t (inch)	Part No.
.02	205623
.04	205624

Wrench No.102148

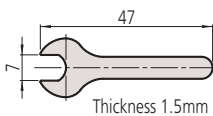

Thickness 1.5mm

Adjustment spacers

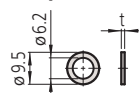

•Metric

t (mm)	Part No.
0.5	205457
1	205458
2	205459
3	205460

•Inch

t (inch)	Part No.
.02	205457
.04	205458
.08	205459
.12	205460

Sub-anvil 50mm (2")

(supplied only for 511-703/733/783)

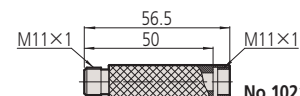

No.102178

Dimensions

Unit: mm

160-250mm/6.5-10", 250-400mm/10-16"

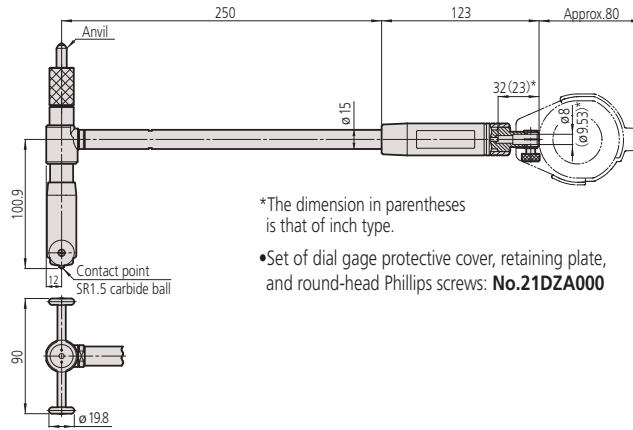

*The dimension in parentheses is that of inch type.

•Set of dial gage protective cover, retaining plate, and round-head Phillips screws: **No.21DZA000**

Anvils

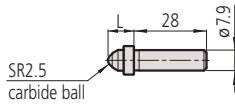

Adjustment spacers

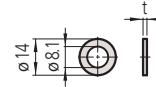

•Metric

Main unit	Marking	Size (mm)	L (mm)	Part No.
511-705	1	160	10	21DZA241A
	2	175	25	21DZA241B
	3	190	40	21DZA241C
	4	205	55	21DZA241D
	5	220	70	21DZA241E
	6	235	85	21DZA241F
511-706	1	250(325)	10	21DZA241A
NOTE: Each dimension in parentheses is that of 511-706, indicating a size if the 75mm sub-anvil is used.	2	265(340)	25	21DZA241B
	3	280(355)	40	21DZA241C
	4	295(370)	55	21DZA241D
	5	310(385)	70	21DZA241E

•Inch

Main unit	Marking	Size (inch)	L (inch)	Part No.
511-735	1	6.500	.394	21DZA241A
	2	7.091	.984	21DZA241B
	3	7.681	1.575	21DZA241C
	4	8.272	2.165	21DZA241D
	5	8.862	2.756	21DZA241E
	6	9.453	3.346	21DZA241F
511-736	1	10.000(13.000)	.394	21DZA241A
NOTE: Each dimension in parentheses is that of 511-736, indicating a size if the 3" sub-anvil is used.	2	10.591(13.591)	.984	21DZA241B
	3	11.181(14.181)	1.575	21DZA241C
	4	11.772(14.772)	2.165	21DZA241D
	5	12.362(15.362)	2.756	21DZA241E

•Metric

t (mm)	Part No.
0.5	205467
1	205461
2	205462
3	205463
4	205464
5	205465
6	205466

•Inch

t (inch)	Part No.
.02	205467
.04	205461
.08	205462
.12	205463
.16	205464
.20	205465
.24	205466

Sub-anvil 75mm (3")

(supplied only for 511-706 (202974) and 511-736 (202975))

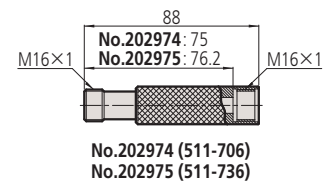

Series 511 Micrometer Head Bore Gage

Accuracy

- Wide-range accuracy: 2 μm
- Repeatability: 0.5 μm
- Adjacent error: 1 μm



511-803

511-804

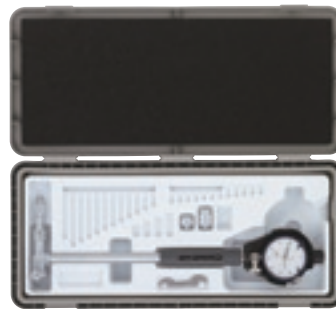

511-804
(The dial gage and protective cover are optional.)



511-806

Measuring Heads

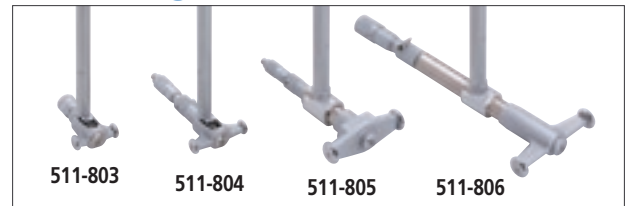

511-803

511-804

511-805

511-806

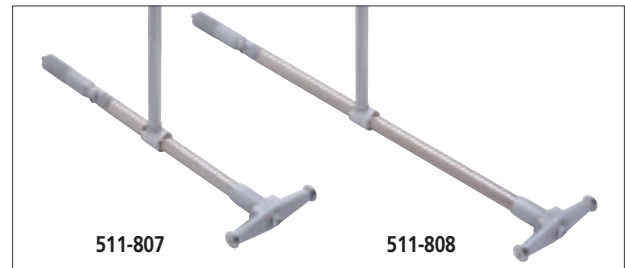

511-807

511-808

Specifications

• Metric

Code No.	Measuring range	Effective stroke of plunger	Measuring force	Guide force	Micrometer head stroke	Sub-anvil	Mass Net
511-803	60-100mm	1.6mm	5N or less	10N or less	10mm	10,20mm	260g
511-804	100-160mm				13mm	10,20,20mm	310g
511-805	150-250mm		6N or less	15N or less	13mm	10,20,20,50mm	680g
511-806	250-400mm				25mm	25,50,50mm	780g
511-807	400-600mm				50mm	50,100mm	1100g
511-808	600-800mm				50mm	50,100mm	1500g

• Inch

Code No.	Measuring range	Effective stroke of plunger	Measuring force	Guide force	Micrometer head stroke	Sub-anvil	Mass Net
511-833	2.4"-4"	.063"	5N or less	10N or less	.4"	.4", .8"	260g
511-834	4"-6.4"				.5"	.4", .8", .8"	310g
511-835	6"-10"		6N or less	15N or less	.5"	.4", .8", .8", 2"	680g
511-836	10"-16"				1"	1", 2", 2"	780g
511-837	16"-24"				2"	2", 4"	1100g
511-838	24"-32"				2"	2", 4"	1500g

*Storage boxes of 511-807,808, 837 and 838 models are made of wood. The boxes of other models are made of plastic.
*It is not permissible to expand measuring range using sub-anvils other than as supplied as standard accessories.
(The measurement accuracy in such cases is not guaranteed.)

Main Standard Accessories

•Metric

Type	Code No.	Dial gage	Dialprotection Cover Ass'y
Micrometer Head type	511-803	Not attached	Not attached
	511-813	2046SB	21DZA000
	511-823	2109SB-10	
	511-804	Not attached	Not attached
	511-814	2046SB	21DZA000
	511-824	2109SB-10	
	511-805	Not attached	Not attached
	511-815	2046SB	21DZA000
	511-825	2109SB-10	
	511-806	Not attached	Not attached
	511-816	2046SB	21DZA000
	511-826	2109SB-10	
	511-807	Not attached	Not attached
	511-817	2046SB	21DZA000
	511-827	2109SB-10	
	511-808	Not attached	Not attached
511-818	2046SB	21DZA000	
511-828	2109SB-10		

•Inch

Type	Code No.	Dial gage	Dialprotection Cover Ass'y
Micrometer Head type	511-833	Not attached	Not attached
	511-843	2922SB	21DZA000
	511-853	2923SB-10	
	511-834	Not attached	Not attached
	511-844	2922SB	21DZA000
	511-854	2923SB-10	
	511-835	Not attached	Not attached
	511-845	2922SB	21DZA000
	511-855	2923SB-10	
	511-836	Not attached	Not attached
	511-846	2922SB	21DZA000
	511-856	2923SB-10	
	511-837	Not attached	Not attached
	511-847	2922SB	21DZA000
	511-857	2923SB-10	
	511-838	Not attached	Not attached
511-848	2922SB	21DZA000	
511-858	2923SB-10		

Dimensions

Unit: mm

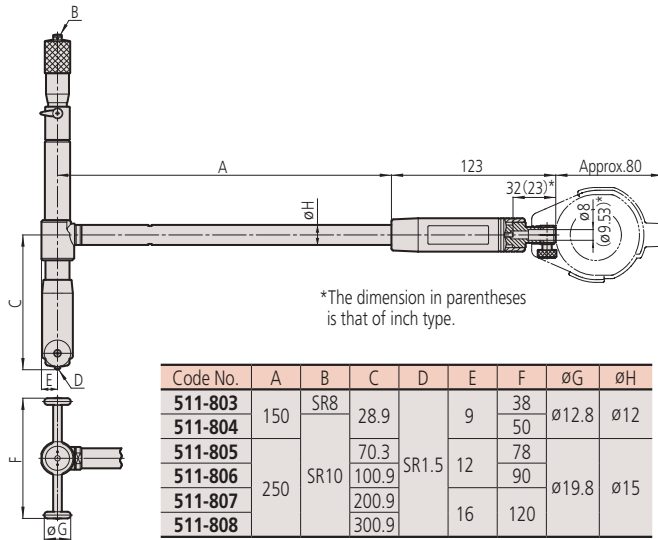

Sub-anvils

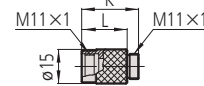

•Metric

Main unit	Marking	K (mm)	L (mm)	Part No.
511-803	10	15	10	208892
511-804	20	25	20	208894
511-805	10	15	10	208892
	20	25	20	208894
	50	55	50	21DAA492

•Inch

Main unit	Marking	K (inch)	L (inch)	Part No.
511-833	.4	.6	.4	208893
511-834	.8	1	.8	208895
511-835	.4	.6	.4	208893
	.8	1	.8	208895
	2	2.2	2	21DAA493

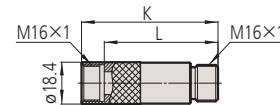

•Metric

Main unit	Marking	K (mm)	L (mm)	Part No.
511-806	25	35	25	208926
	50	60	50	208928
511-807	50	60	50	208928
511-808	100	110	100	208932

•Inch

Main unit	Marking	K (inch)	L (inch)	Part No.
511-836	1	1.4	1	208927
	2	2.4	2	208929
511-837	2	2.4	2	208929
511-838	4	4.4	4	208933

Wrenches

No.202863

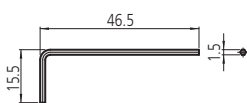

No.301336

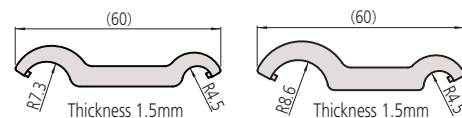

No.200154

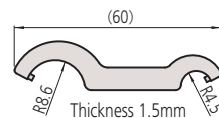

•Metric

Code No.	Part No.
511-803	301336 (2piece) 202863 (1piece)
511-804	301336 (2piece)
511-805	301336 (2piece)
511-806	200154 (2piece)
511-807	200154 (2piece)
511-808	200154 (2piece)

•Inch

Code No.	Part No.
511-833	301336 (2piece) 202863 (1piece)
511-834	301336 (2piece)
511-835	301336 (2piece)
511-836	200154 (2piece)
511-837	200154 (2piece)
511-838	200154 (2piece)

Bore Gage Accessories (Options)

Extension Rods

- Extension rods (optional) are available to assist in deep-hole measurement.
- When a rod is connected, there might be error margins due to the distortion of the rod, etc. In order to keep the error margins minimum, please don't connect more than 2 rods to a bore gage.
- The maximum extension is limited to 1,000 mm.
- If using an extension rod longer than 500 mm, use the bore gage only in the vertical orientation.

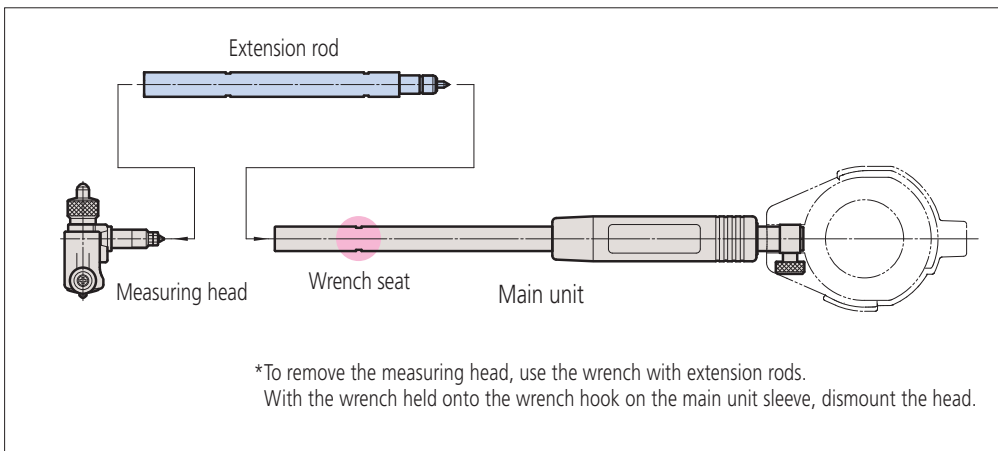

Specifications

Extension rod length					Extension rod diameter	Wrench Part No.	Applicable measuring range
125mm/5"	250mm/10"	500mm/20"	750mm/30"	1,000mm/40"			
953549	953550	953551	—	—	ø9	102148	18-35mm/.7"-1.4"
953552	953553	953554	953555	953556	ø12	212556	35-60mm/1.4"-2.5"
							50-150mm/2"-6"
							100-160mm/4"-6.5"
							60-100mm/2.4"-4"
							100-160mm/4.5"-6"
953557	952361	953558	953559	953560	ø15	212556	160-250mm/6.5"-10"
							250-400mm/10"-16"
							150-250mm/6"-10"
							250-400mm/10"-16"
							400-600mm/16"-24"
600-800mm/24"-32"							

Dial Protection Cover

- It is possible to mount either flat back or lug-on-center back panels on the dial gage protective cover.

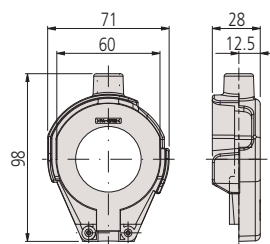
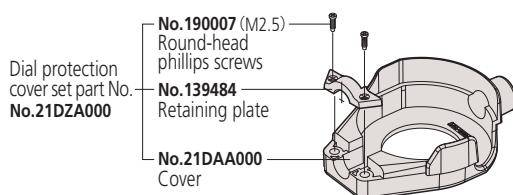

515-Series Bore Gage Zero-Checker

- The datum point of bore gages with a measuring range of 18 to 400mm can be easily set using an appropriate gauge block in conjunction with this accessory.

• Specifications

Order No.	Datum point checking range (mm)
515-590	18-400

• Accuracy

Flatness of parallel jaws: 0.5 μ m (parallelism 1 μ m)

515-590
CCG-400



Standard configuration:

Stand
Attachment A, B, C (1 piece each)
Dedicated jaws (2 pieces)

177-Series Setting Rings

- These rings are used for checking the datum point of bore gages and others. Also, if a setting ring of an optimal size is prepared, it can be used for calibration. (For ordering details, refer to the Mitutoyo General Catalog No.E2010.)

Steel setting rings



Ceramic setting rings





Export permission by the Japanese government may be required for exporting our products according to the Foreign Exchange and Foreign Trade Law. Please consult our sales office near you before you export our products or you offer technical information to a nonresident.

- Coordinate Measuring Machines
- Vision Measuring Systems
- Form Measurement
- Optical Measuring
- Sensor Systems
- Test Equipment and Seismometers
- Digital Scale and DRO Systems
- Small Tool Instruments and Data Management

Note: All information regarding our products, and in particular the illustrations, drawings, dimensional and performance data contained in this pamphlet, as well as other technical data are to be regarded as approximate average values. We therefore reserve the right to make changes to the corresponding designs, dimensions and weights. The stated standards, similar technical regulations, descriptions and illustrations of the products were valid at the time of printing. Only quotations submitted by ourselves may be regarded as definitive. Our products are classified as regulated items under Japanese Foreign Exchange and Foreign Trade Law. Please consult us in advance if you wish to export our products to any other country. If the purchased product is exported, even though it is not a regulated item (Catch-All controls item), the customer service available for that product may be affected. If you have any questions, please consult your local Mitutoyo sales office.

Mitutoyo Corporation
20-1, Sakado 1-chome,
Takatsu-ku, Kawasaki-shi,
Kanagawa 213-8533, Japan
T +81 (0) 44 813-8230
F +81 (0) 44 813-8231
<http://www.mitutoyo.co.jp>

